

STANDALONE PRINTABLES

IN THIS CHAPTER

FORMS AND REGISTRATION

Call for Volunteers (in English and Spanish)	216
Permission to Film or Photograph (in English and Spanish)	218

EARLY LITERACY

Activity Log	220
Bookmarks (English and Spanish)	222
Adventure Bingo (in English and Spanish)	224
Reed Reads (English & Spanish)	226
Ship Puzzle.....	228
Dot To Dot Camper	229
Map Handwriting Practice	230
Map Spelling Practice	231
Ladybug Coloring	232
Bird Pixel Drawing.....	233
Finger Puppets.....	234
Alphabet Treasure Hunt.....	235
Detective Shadow Matching.....	236
Pattern Puzzle Home	237
Space Coloring Sheet.....	238
Space Maze.....	239
Space I Spy.....	240
Deletrea la palabra	241

CHILDREN

Registration and Reading Contract.....	242
Reading Log.....	244
Bookmarks (English and Spanish)	246
Adventure Bingo	248
Reading Bingo	250
Mountainscape Cube	252
Adventure Sudoku.....	254
Adventure Sudoku Answers	256
Beach Crossword	257

3D Boat.....	258
Rompecabezas de búsqueda de palabras.....	259
Crucigrama para niños.....	260
Forest Coloring.....	261
Camping Jumble.....	262
Camping Jumble Answers.....	264
Camping Checklist	265
3D Bird	267
3D Dodecahedron	268
Secret Garden Coloring.....	269
Detective Sudoku.....	270
3D Sherlock.....	271
Tetris-Like Puzzle.....	272
Moon & Stars Coloring.....	273
Sleepover Checklist.....	274

TEENS

Teen Registration and Contract.....	276
Reading Log Time	278
Reading Log Books.....	280
Bookmarks	282
Book Genre Bingo.....	284
Road Trip Coloring.....	286
3D Robot.....	287
3D Castle.....	288
Pixel Art Skateboarder	289
Teen Coloring Fashion	290
Teen Coloring Zendoodle.....	291
Nature Coloring	292
Bird Coloring	293

Adventure Begins at Your Library!

Call for Volunteers

for the 2024 Summer Library Program

Dear Parents and Friends:

We are looking for volunteers to help us offer more activities for our summer program.

“Adventure Begins at Your Library!” is designed to encourage children to continue reading during vacation so that valuable reading skills will not be lost. In addition, we hope to offer a variety of activities for children, teens, and adults. If you are interested in helping, please fill out the form below and return it by _____.

Yes, I want to help at the library this summer. I am willing to:

- Help with registration and recording reading logs.
- Solicit donations of incentive prizes from local businesses.
- Assist the librarian with storytime or other programs.
- Offer or help with a craft program.
- Help with games or sports activities.
- Create a display or help decorate the room.
- Chaperone a reading party or field trip.
- Provide refreshments for a special event.
- Offer a workshop using a special skill I have.
- Translate during a bilingual program.

Name: _____

Address: _____

Telephone: _____

Email: _____



¡La aventura comienza en tu biblioteca!

Llamado para voluntarios

durante de programa de biblioteca de verano de 2024

Estimados padres y amigos:

Nosotros estamos buscando voluntarios para ayudarnos a ofrecer más actividades para nuestro programa de verano. “¡La aventura comienza en tu biblioteca!” está diseñado para alentar a los niños que continúen leyendo durante las vacaciones para no perder las habilidades de lectura. Además, esperamos ofrecer una variedad de actividades para niños, adolescentes, y adultos. Si estás interesado en ayudarnos, complete el siguiente formulario y envíelo a la biblioteca o escuela hasta el _____.

Sí, quiero ayudar en la biblioteca este verano. Estoy dispuesto a:

- ___ Ayudar con la inscripción y registro de los libros leídos por los niños.
- ___ Solicitar donaciones para premios de incentivo de negocios locales.
- ___ Ayudar a la bibliotecaria con las historias u otros programas.
- ___ Ofrecer o ayudar con el programa de arte.
- ___ Crear una cartelera o ayudar a decorar una sala.
- ___ Supervisar una fiesta de lectura o excursión.
- ___ Servir refrescos en un evento especial.
- ___ Ofrecer la realización de un taller usando una habilidad especial que yo tengo.
- ___ Traducir durante programas bilingües.

Nombre: _____

Dirección: _____

Teléfono: _____

Email: _____

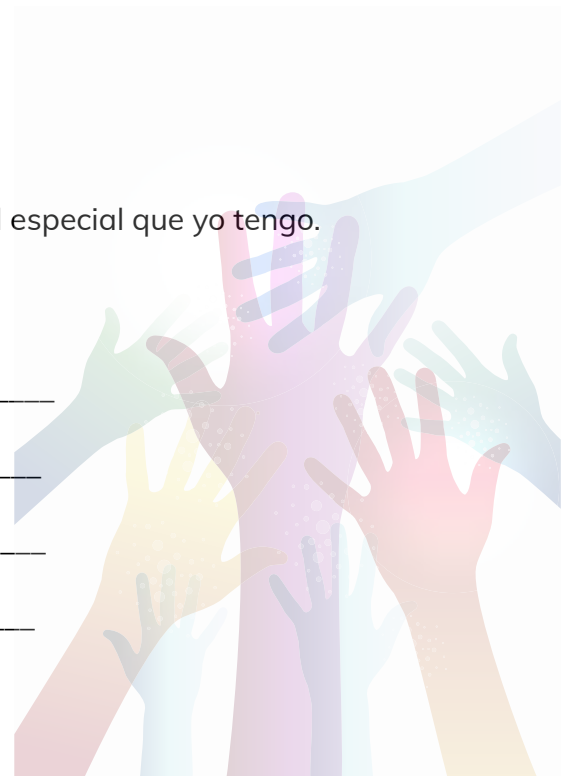

Adventure Begins at Your Library!

Permission to Record and/or Photograph

Permission is not required to participate in library events.

I, _____, am 18 years or older.
(name, please print)

I, _____, am the parent/guardian of _____.
(name, please print) (name, please print)

I understand that the _____ may record or photograph the event or activity in which I am (or my child is) participating for the purpose of promoting its services and programs. I give permission with the following understanding: No compensation of any kind will be paid to me (or my child) at this time or in the future for the use of my (or my child's) likeness.

Signature _____ Date: _____

Address: _____ Zip Code: _____

Phone or email: _____

Adventure Begins at Your Library!

Permission to Record and/or Photograph

Permission is not required to participate in library events.

I, _____, am 18 years or older.
(name, please print)

I, _____, am the parent/guardian of _____.
(name, please print) (name, please print)

I understand that the _____ may record or photograph the event or activity in which I am (or my child is) participating for the purpose of promoting its services and programs. I give permission with the following understanding: No compensation of any kind will be paid to me (or my child) at this time or in the future for the use of my (or my child's) likeness.

Signature _____ Date: _____

Address: _____ Zip Code: _____

Phone or email: _____

¡La aventura comienza en tu biblioteca!

Permiso para filmar y/o fotografiar

No se necesita permiso para participar en los eventos de la ciudad.

Yo, _____, tengo por lo menos 18 años de edad.
(nombre, en imprenta)

Yo, _____, soy padre o tutor legal de _____.
(nombre, en imprenta) (nombre, en imprenta)

Comprendo que _____ puede fotografiar o filmar los eventos o actividades en las cuales you estoy (o mi hijo está) participando. Doy permiso para utilizar fotografías o filmaciones mías (o de mi hijo) con el propósito de promocionar sus servicios/programas. Doy permiso y tengo claro lo siguiente: No se me pagará compensación de ningún tipo (ni tampoco a mi hijo) en esta oportunidad ni en el futuro por la utilización de mi imagen (o la imagen de mi hijo).

Firma: _____ Fecha: _____

Dirección : _____ Zip: _____

Teléfono o email _____

¡La aventura comienza en tu biblioteca!

Permiso para filmar y/o fotografiar

No se necesita permiso para participar en los eventos de la ciudad.

Yo, _____, tengo por lo menos 18 años de edad.
(nombre, en imprenta)

Yo, _____, soy padre o tutor legal de _____.
(nombre, en imprenta) (nombre, en imprenta)

Comprendo que _____ puede fotografiar o filmar los eventos o actividades en las cuales you estoy (o mi hijo está) participando. Doy permiso para utilizar fotografías o filmaciones mías (o de mi hijo) con el propósito de promocionar sus servicios/programas. Doy permiso y tengo claro lo siguiente: No se me pagará compensación de ningún tipo (ni tampoco a mi hijo) en esta oportunidad ni en el futuro por la utilización de mi imagen (o la imagen de mi hijo).

Firma: _____ Fecha: _____

Dirección : _____ Zip: _____

Teléfono o email _____

Adventure Begins at Your Library!

Activity Log

Complete the activities below.

**Read a
wordless book.**

Sing the ABCs.

**Play with a
friend.**

**Attend a library
program.**

**Recite some
nursery rhymes.**

**Dance to fun
music.**

**Check out a
book.**

**Read a bedtime
story.**



¡La aventura comienza en tu biblioteca!

Registro de actividades

Completar las siguientes actividades.

Leer un libro sin palabras.

Cantar una canción de ABC.

Jugar con un amigo.

Ir a un programa de la biblioteca.

Recitar algunas canciones de cuna.

Baila al ritmo canción.

Saca un libro de la biblioteca.

Leer un cuento para antes de dormir.



loved this book

Adventure Begins at Your Library!



loved this book

Adventure Begins at Your Library!



loved this book

Adventure Begins at Your Library!



amaba este libro

¡La aventura comienza en tu biblioteca!



amaba este libro

¡La aventura comienza en tu biblioteca!



amaba este libro

¡La aventura comienza en tu biblioteca!



Adventure Begins at Your Library!

Adventure Bingo



Go somewhere
new.

Put some
treasure in a
box.

Read a book
about going on
vacation.

Make a blanket
fort.

Talk to a new
person.

Try a new
instrument.

Draw a picture
with your eyes
closed.

Sing a new
song.

Look for wildlife
outside.

¡La aventura comienza en tu biblioteca!

Bingo aventura



Ve a un sitio nuevo.

Guarda un tesoro en una caja.

Lee un libro sobre las vacaciones.

Haz una cobija.

Habla con una persona nueva.

Toca un instrumento nuevo.

Haz un dibujo con los ojos cerrados.

Canta una canción nueva.

Busque fauna en el exterior.

REED WANTS TO READ

Reed Books is ready for his next adventure! Help him find his way out of the maze without running into any letters.



REED QUIERE LEER

¡Reed Books está listo para su próxima aventura! Ayúdalo a encontrar la salida del laberinto sin encontrándose con alguna letra.



Move along the path without going over the edges

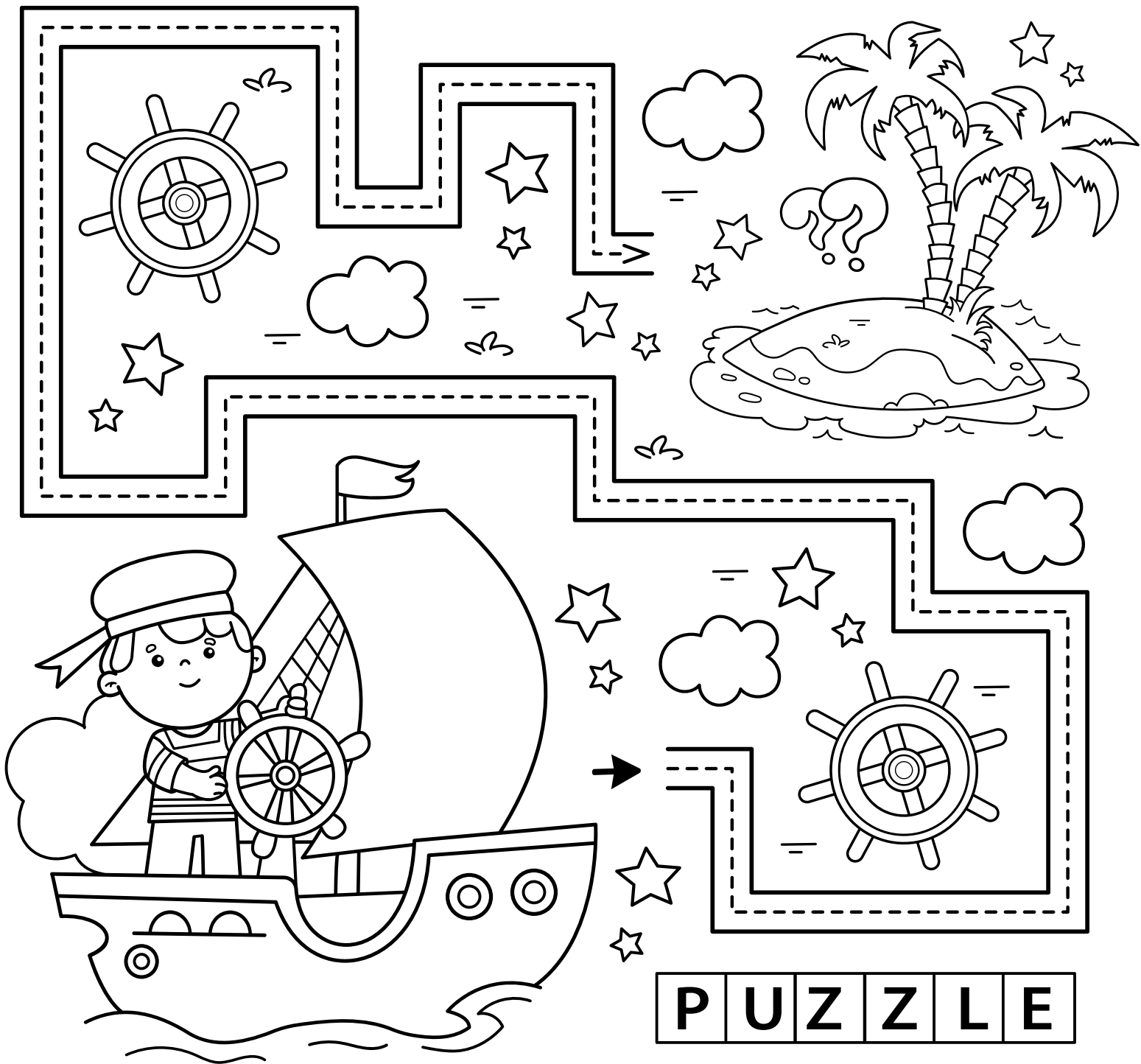

Dot to Dot



Camper

1-10

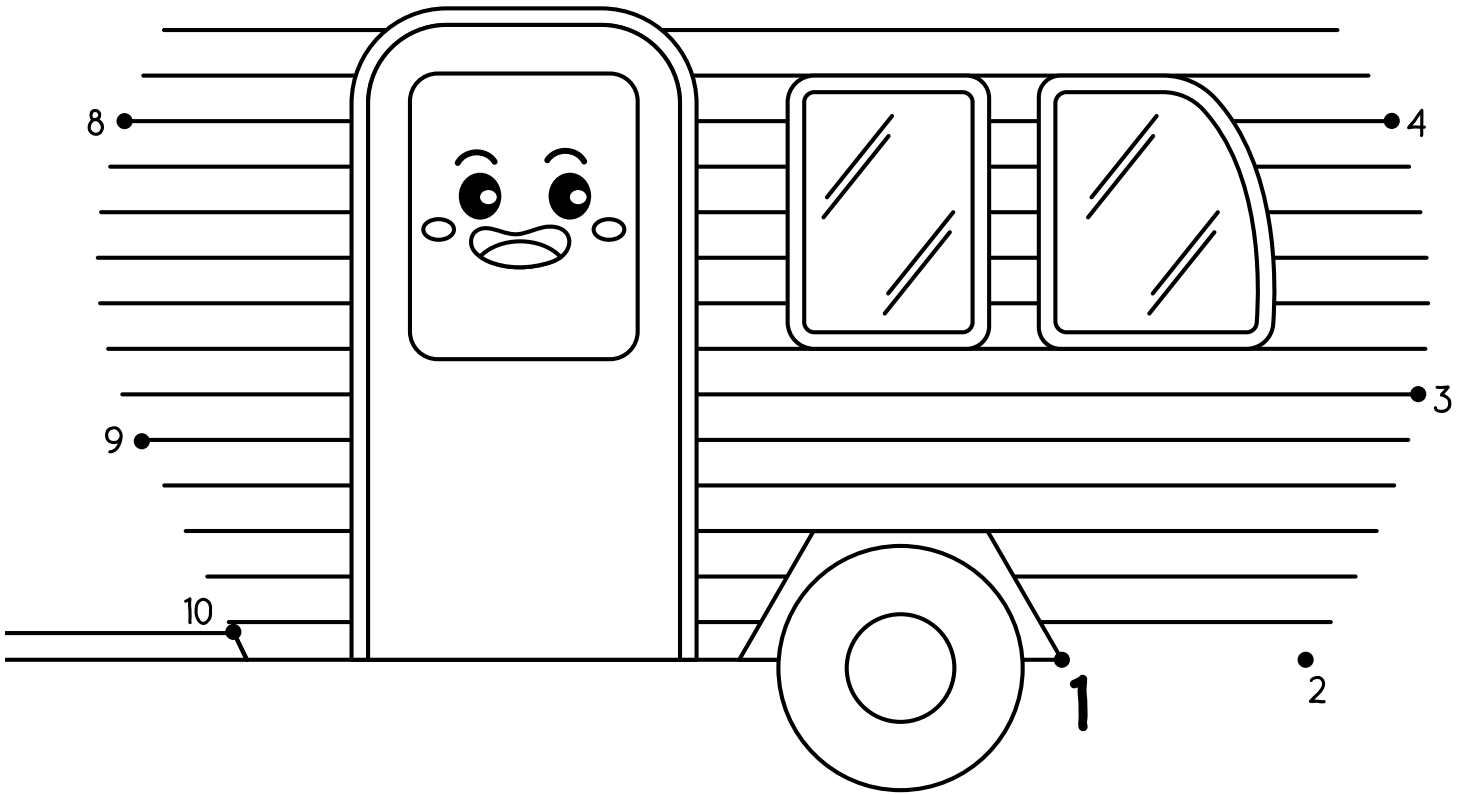
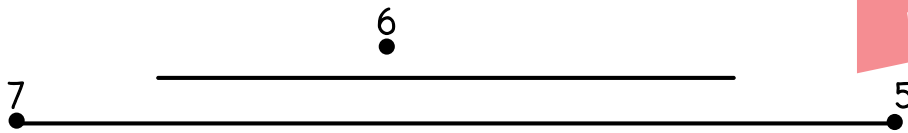

HANDWRITING PRACTICE

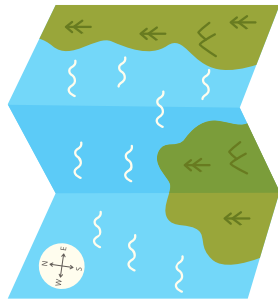
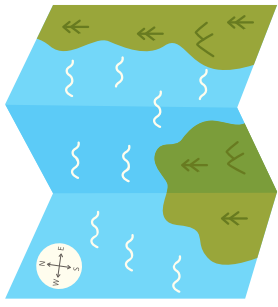
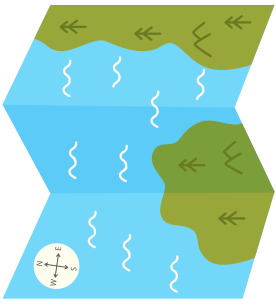

TRACE THE LETTERS

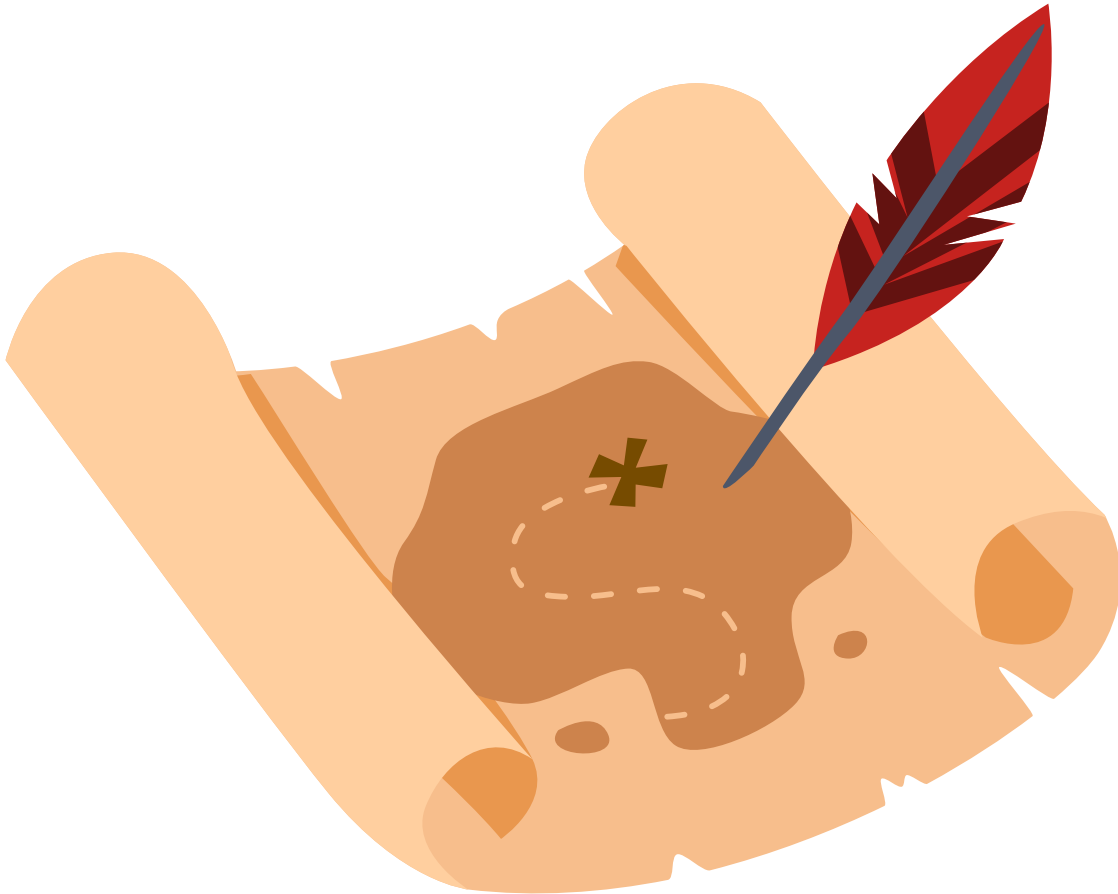

M A P

Lady Bug

Trace the circles and color the lady bugs

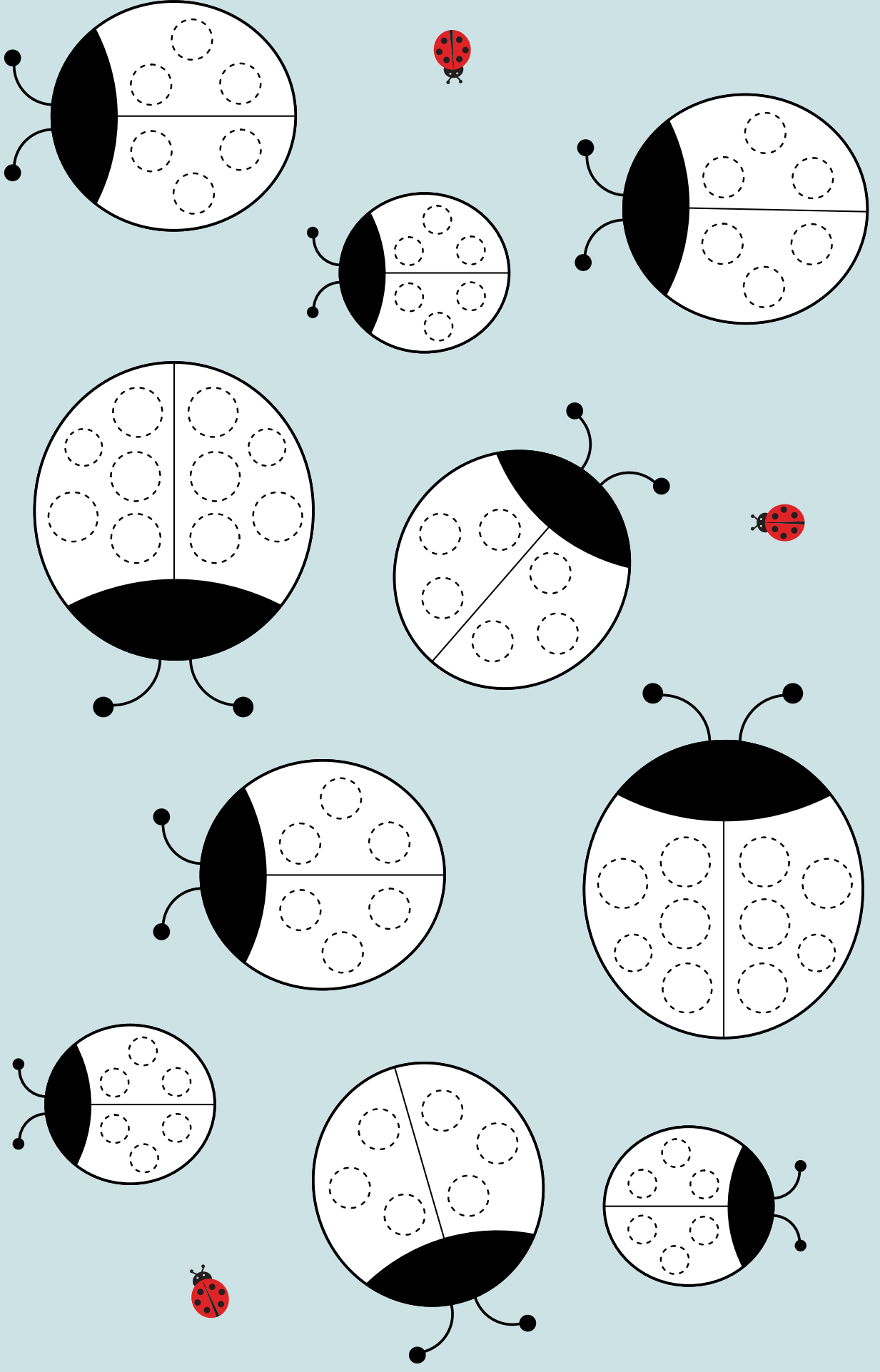

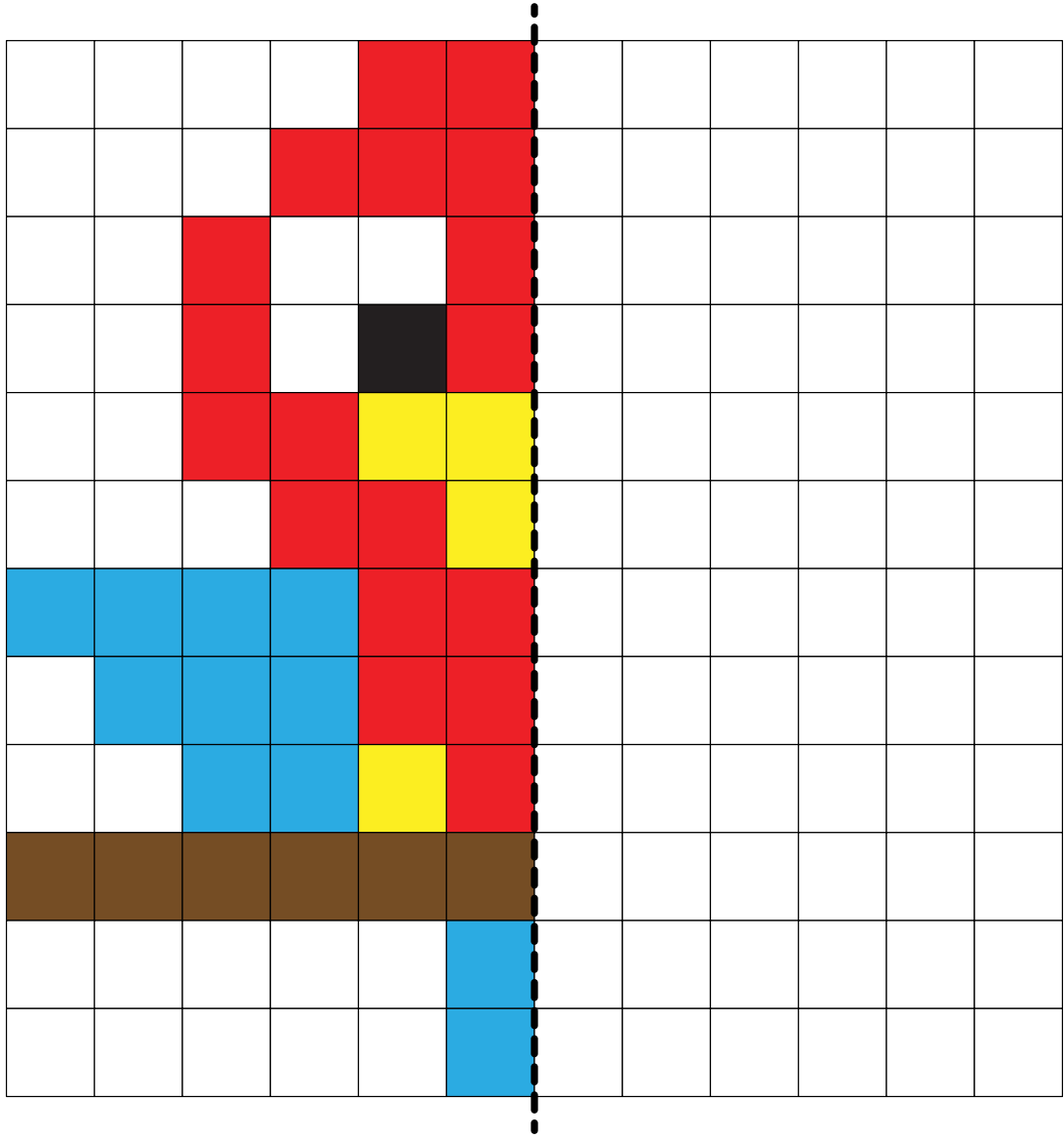

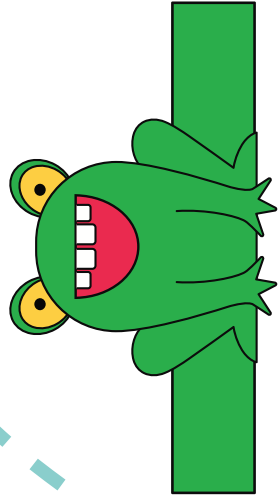
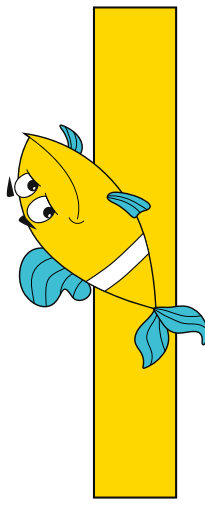
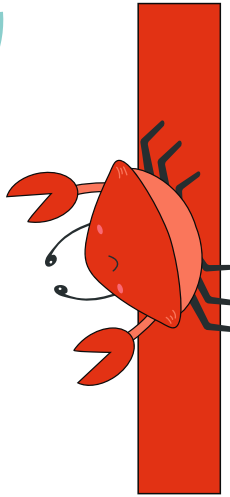
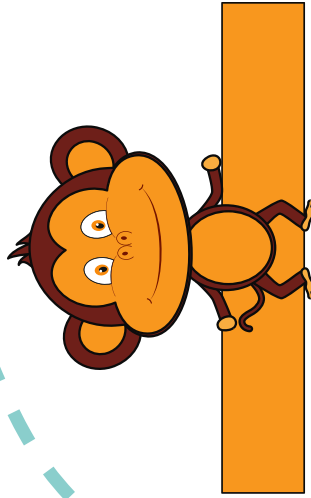
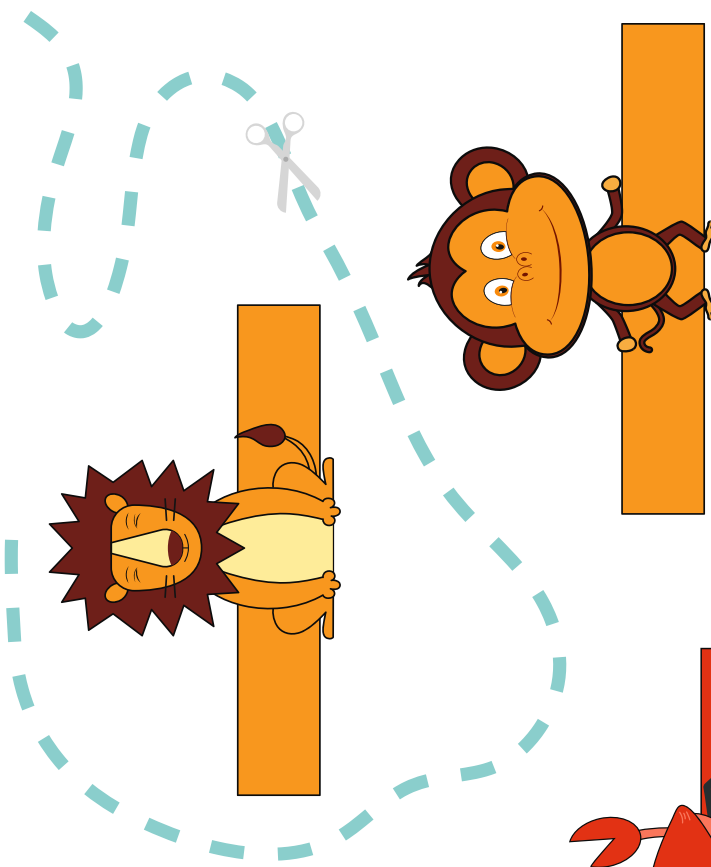
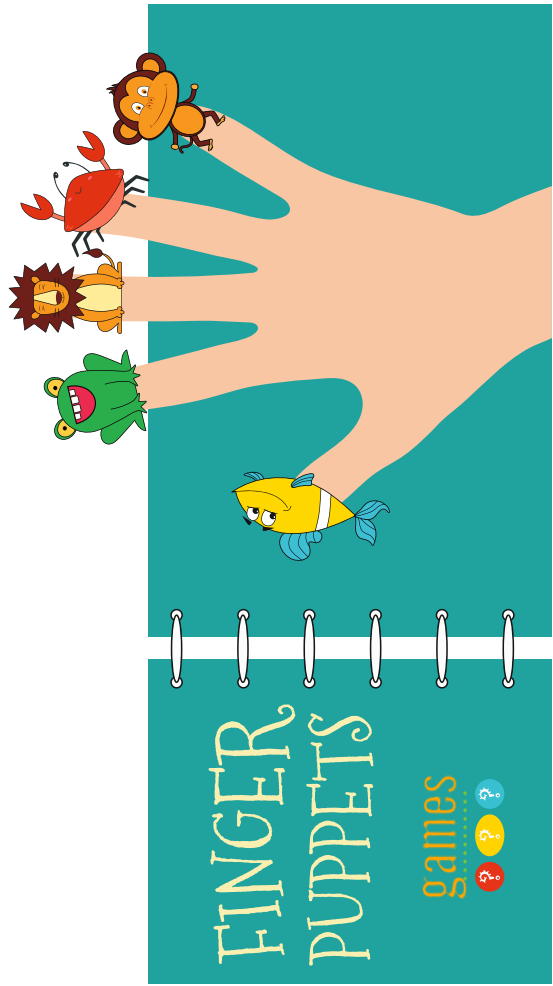

tips

Cut out the puppet with scissors

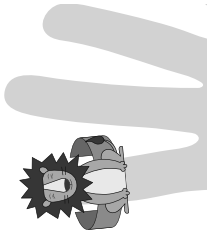



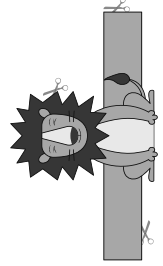































Wrap it around your finger and fasten the open ends with glue

























Fill in the box.















												
A	B	C	D	E	F	G	H	I	J	K	L	M
												
N	O	P	Q	R	S	T	U	V	W	X	Y	Z

										



GAME
FOR KIDS



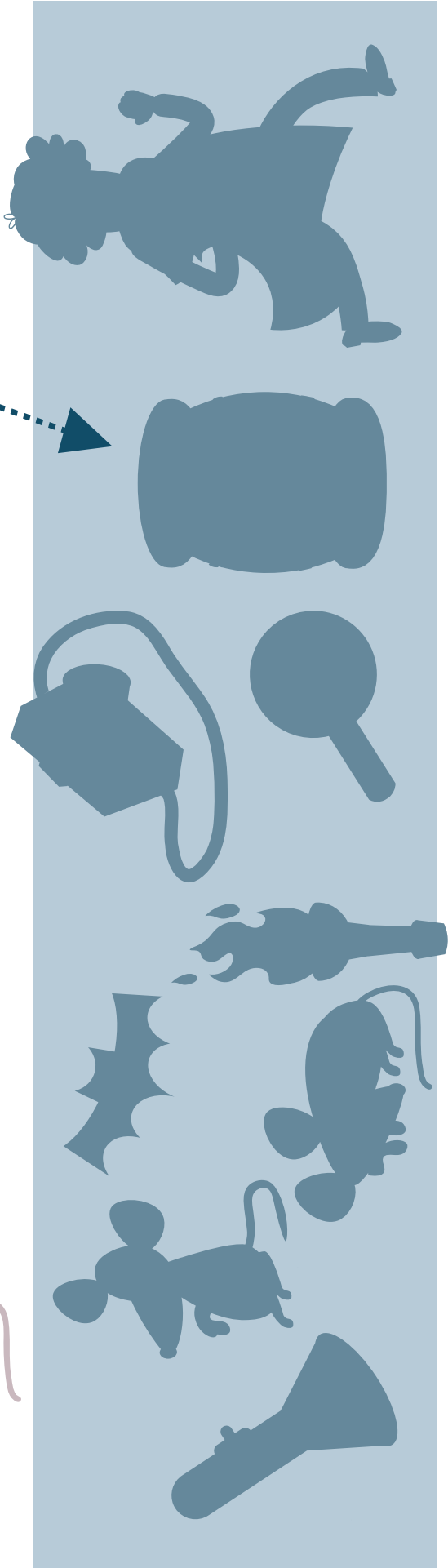

Follow this pattern ●▲●▲
to help the pig return home.





COLOR BY NUMBERS

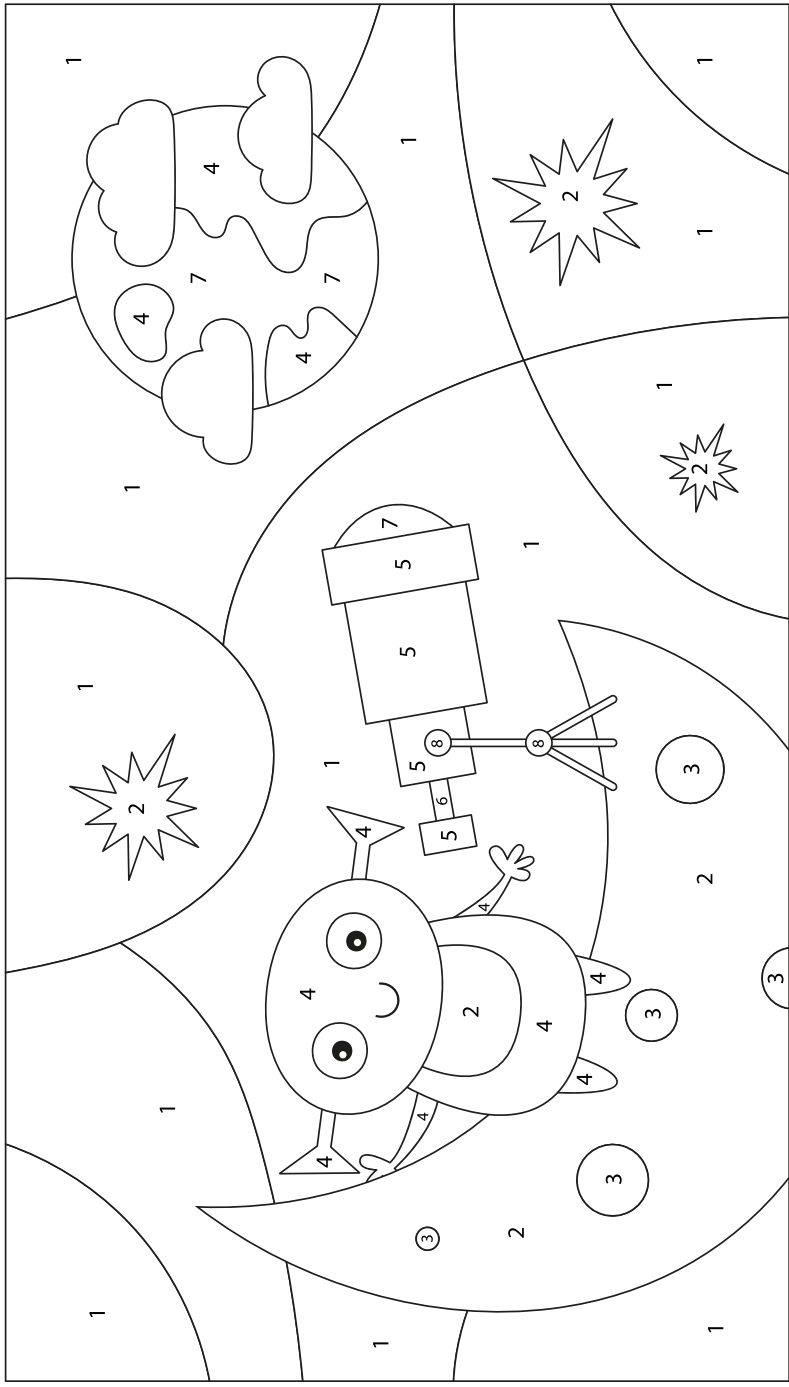

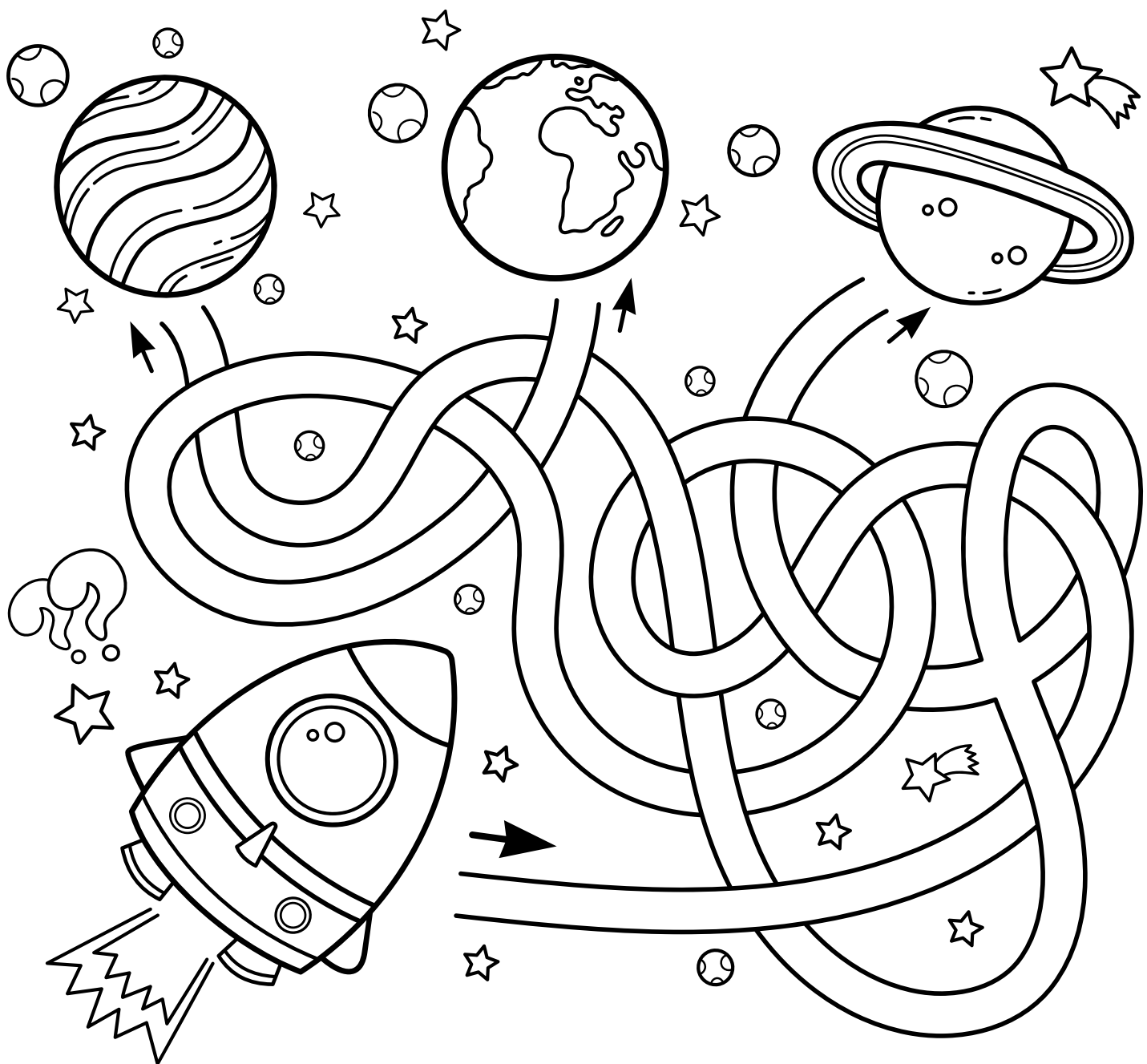

SPACE I-SPY



HOW MANY CAN YOU FIND?

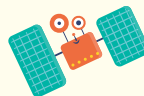

DELETREA LA PALABRA

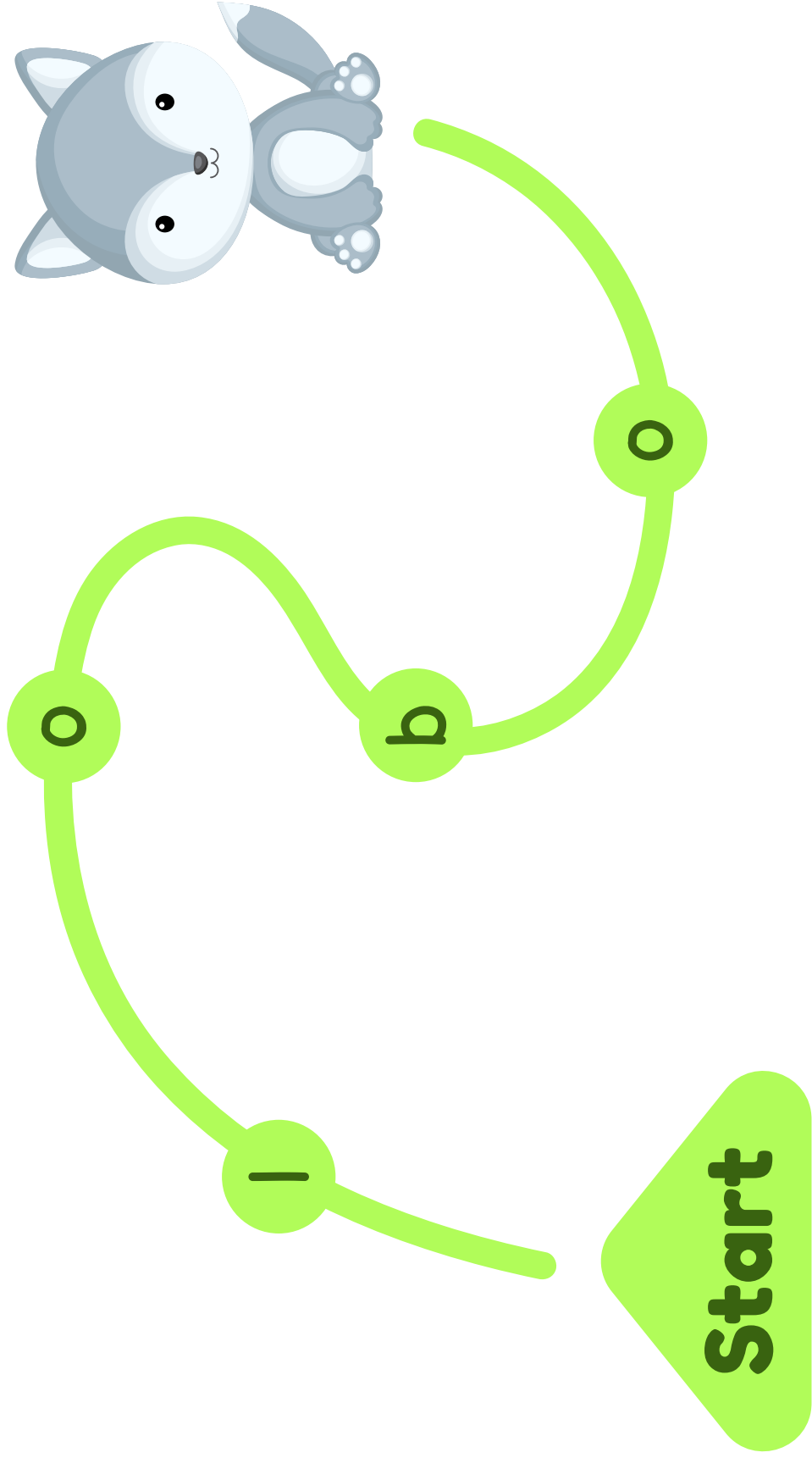

Registration

for the 2024 Summer Library Program:
Adventure Begins at Your Library!

Reader's name: _____ Age: _____

Address: _____

Parent phone or email: _____

School: _____ Grade in September: _____

Circle one: independent reader family reader

Completed program: Yes No

Reading Contract

for the 2024 Summer Library Program:
Adventure Begins at Your Library!



I, _____, agree to read _____ books, minutes, or pages (circle one) this summer as part of the 2024 summer library program.

Signature of reader: _____ Date: _____

Signature of librarian: _____

Inscripción

para el programa de biblioteca de verano 2024

¡La aventura comienza en tu biblioteca!

Nombre: _____ Edad: _____

Dirección: _____

Teléfono o email de los padres: _____

Escuela: _____ Año en septiembre: _____

Encierre uno en un círculo: lector independiente lector en familia

Completó el programa: Sí No

Contrato de lectura

para el programa de biblioteca de verano 2024

¡La aventura comienza en tu biblioteca!

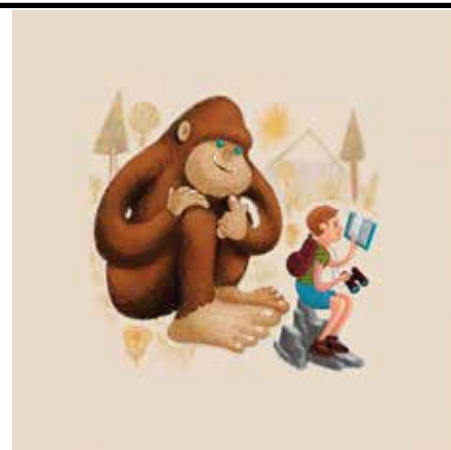

Acepto leer _____ número de libros, minutos, o páginas (encierre uno en un círculo) este verano como parte del programa de lectura de verano 2024.

Firma del lector: _____ Hecha: _____

Firma de bibliotecario: _____

This book is recommended by

Adventure Begins at Your Library!



This book is recommended by

Adventure Begins at Your Library!



This book is recommended by

Adventure Begins at Your Library!



Este libro está recomendado por

¡La aventura comienza en tu biblioteca!



Este libro está recomendado por

¡La aventura comienza en tu biblioteca!



Este libro está recomendado por

¡La aventura comienza en tu biblioteca!



Adventure Begins at Your Library!

SUMMER ADVENTURE BINGO



TRAVEL TO ANOTHER WORLD (IN A BOOK)	ATTEND A COMMUNITY EVENT	WATCH A MOVIE ABOUT AN ADVENTURE	GO TO AN AMUSEMENT PARK	READ A BOOK ABOUT MOVING TO A NEW HOUSE
COLLECT FIVE SHELLS OR ROCKS	GO FOR A HIKE IN THE WOODS	WRITE A SHORT ADVENTURE STORY	ATTEND AN EVENT AT THE LIBRARY	START A NEW COLLECTION (OF ANYTHING!)
READ A BOOK ABOUT AN ADVENTURE	VISIT A FRIEND	LISTEN TO MUSIC YOU'VE NEVER HEARD BEFORE	DRAW SOMETHING YOU'VE NEVER DRAWN BEFORE	PLANT SOMETHING
VISIT ANOTHER CITY OR TOWN	LEARN ABOUT THE BIRDS IN YOUR NEIGHBORHOOD	DAYDREAM / USE YOUR IMAGINATION	TRAVEL TO ANOTHER WORLD (IN A MOVIE)	GO TO A PARK
PLAY A BOARD GAME	PLAY A GAME OUTSIDE	READ A BOOK THAT FEATURES A BOAT	PHOTOGRAPH A BEAUTIFUL LANDMARK	WATCH A TV SHOW SET IN ANOTHER COUNTRY

¡La aventura comienza en tu biblioteca!

BINGO DE VERANO DE AVENTURAS









VIAJAR A OTRO MUNDO (EN UN LIBRO)	IR A DAR UNA CAMINATA EN EL BOSQUE	ESCRIBE UNA HISTORIA CORTA DE AVENTURAS.	ASISTIR A UN EVENTO COMUNITARIO	JUGAR UN JUEGO DE MESA
RECOGE CINCO CONCHAS O ROCAS.	VISITAR A UN AMIGO	VISITA OTRA CIUDAD O PUEBLO	APRENDE SOBRE LAS AVES DE TU VECINDARIO	VER UNA PELÍCULA SOBRE UNA AVENTURA
LEER UN LIBRO SOBRE UNA AVENTURA	DAYDREAM / USA TU IMAGINACIÓN	FOTOGRAFIAR UN HERMOSO PUNTO DE REFERENCIA	JUEGA UN JUEGO AFUERA	LEER UN LIBRO QUE TENGA UN BARCO
VER UN PROGRAMA DE TELEVISIÓN AMBIENTADO EN OTRO PAÍS	IR A UN PARQUE	ESCUCHA MÚSICA QUE NUNCA HAS ESCUCHADO ANTES	COMIENCE UNA NUEVA COLECCIÓN (¡DE CUALQUIER COSA!)	DIBUJA ALGO QUE NUNCA HAYAS DIBUJADO ANTES
LEER UN LIBRO SOBRE MUDARSE A UNA NUEVA CASA	PLANTA ALGO	VIAJAR A OTRO MUNDO (EN UNA PELÍCULA)	ASISTIR A UN EVENTO EN LA BIBLIOTECA	IR A UN PARQUE DE DIVERSIONES

Summer Reading Bingo

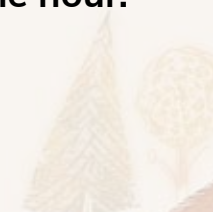
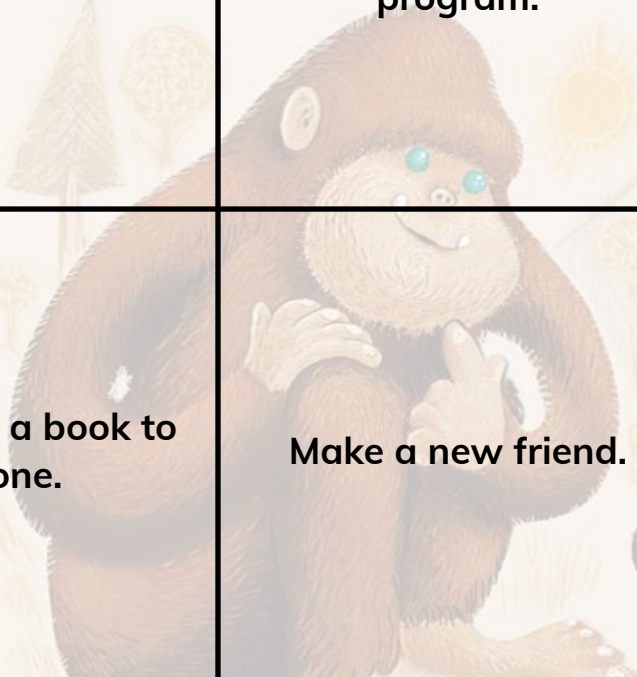
Adventure Begins at Your Library!

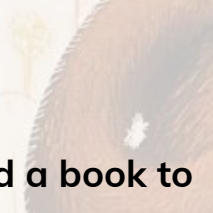
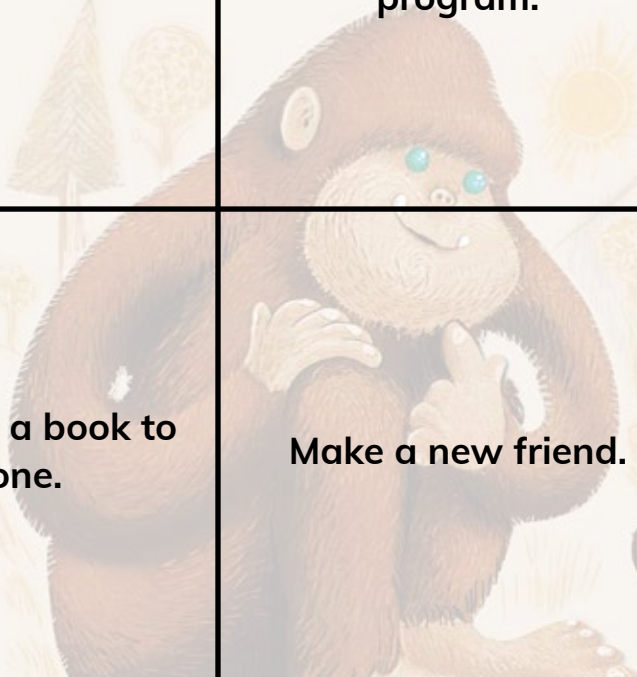
Complete all nine squares.

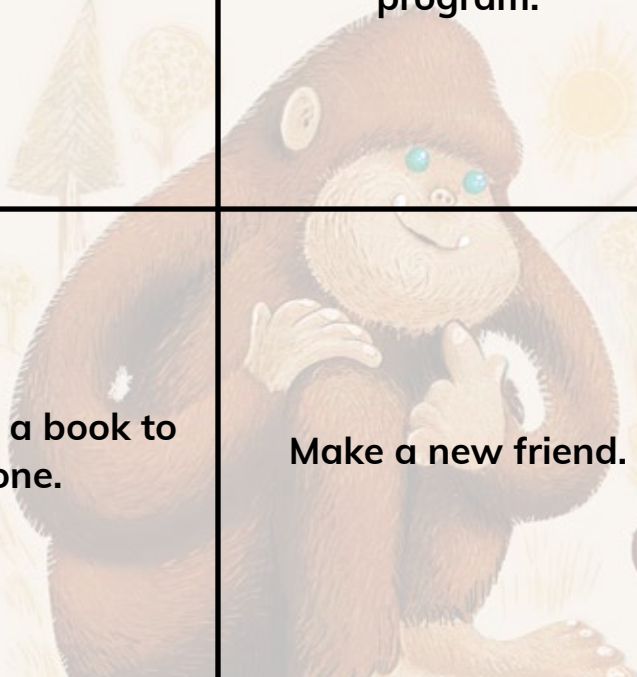
Name: _____

<p>Read one hour.</p> 	<p>Attend a library program.</p> 	<p>Volunteer at the library one hour.</p> 
<p>Recommend a book to someone.</p> 	<p>Make a new friend.</p> 	<p>Read one hour.</p> 
<p>Read one hour.</p> 	<p>Ask a librarian a question.</p> 	<p>Read one hour.</p> 

Bingo de lectura de verano

¡La aventura comienza en tu biblioteca!

Completa todos los nueve cuadrados.

Nombre: _____

<p>Lee una hora.</p>	<p>Asiste a un programa de la biblioteca.</p>	<p>Participa como voluntario en la biblioteca por una hora.</p>
<p>Recomendar un libro a alguien.</p>	<p>Hacer un nuevo amigo.</p>	<p>Lee una hora.</p>
<p>Lee una hora.</p>	<p>Hágale una pregunta al bibliotecario.</p>	<p>Lee una hora.</p>



MAKE A 3D MOUNTAINSCAPE!

Add an adventure to this mountainscape, then cut along the solid lines. Fold along the dotted lines, and tape to secure it in place.

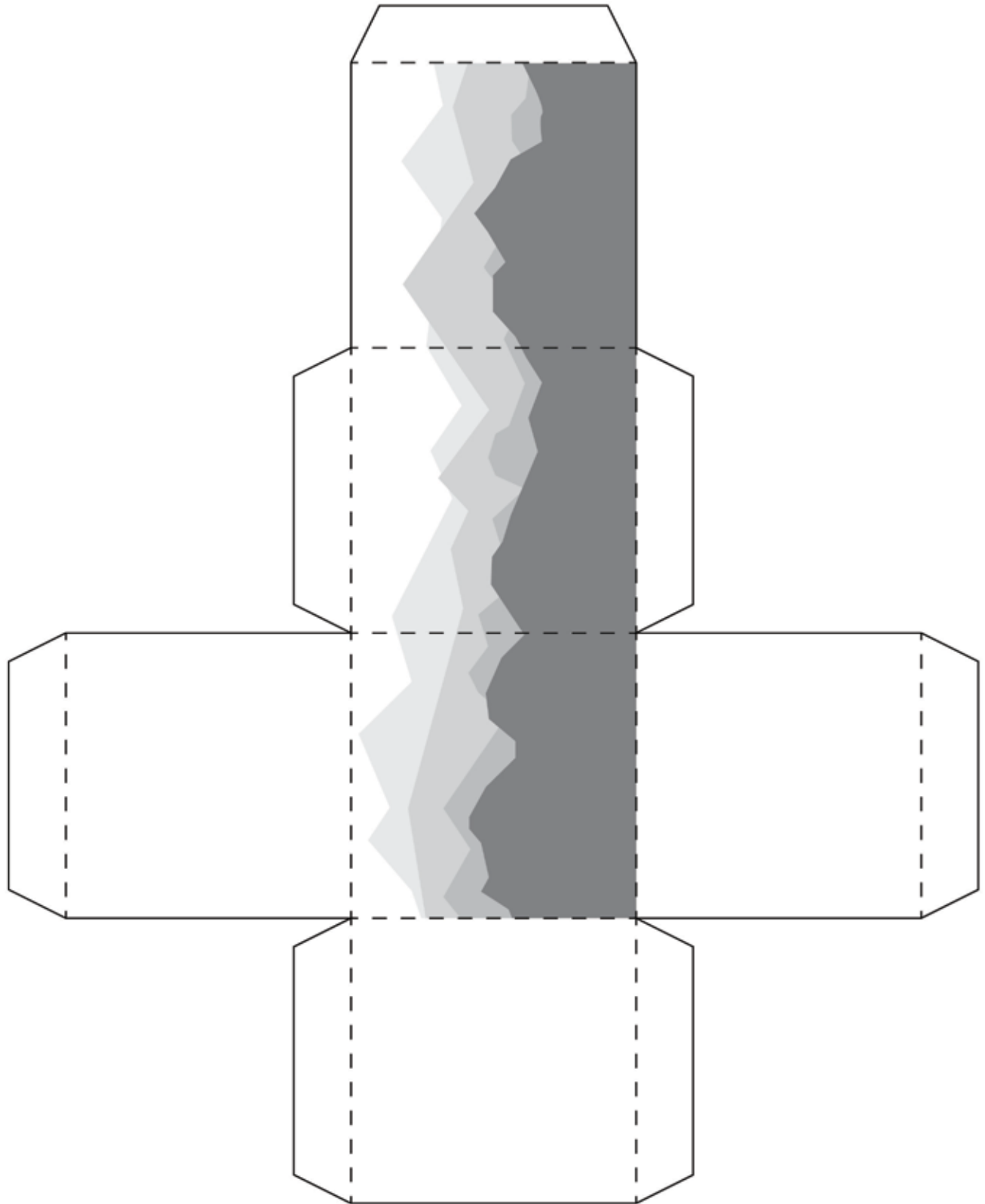

¡HAZ UN PAISAJE MONTAÑOSO EN 3D!



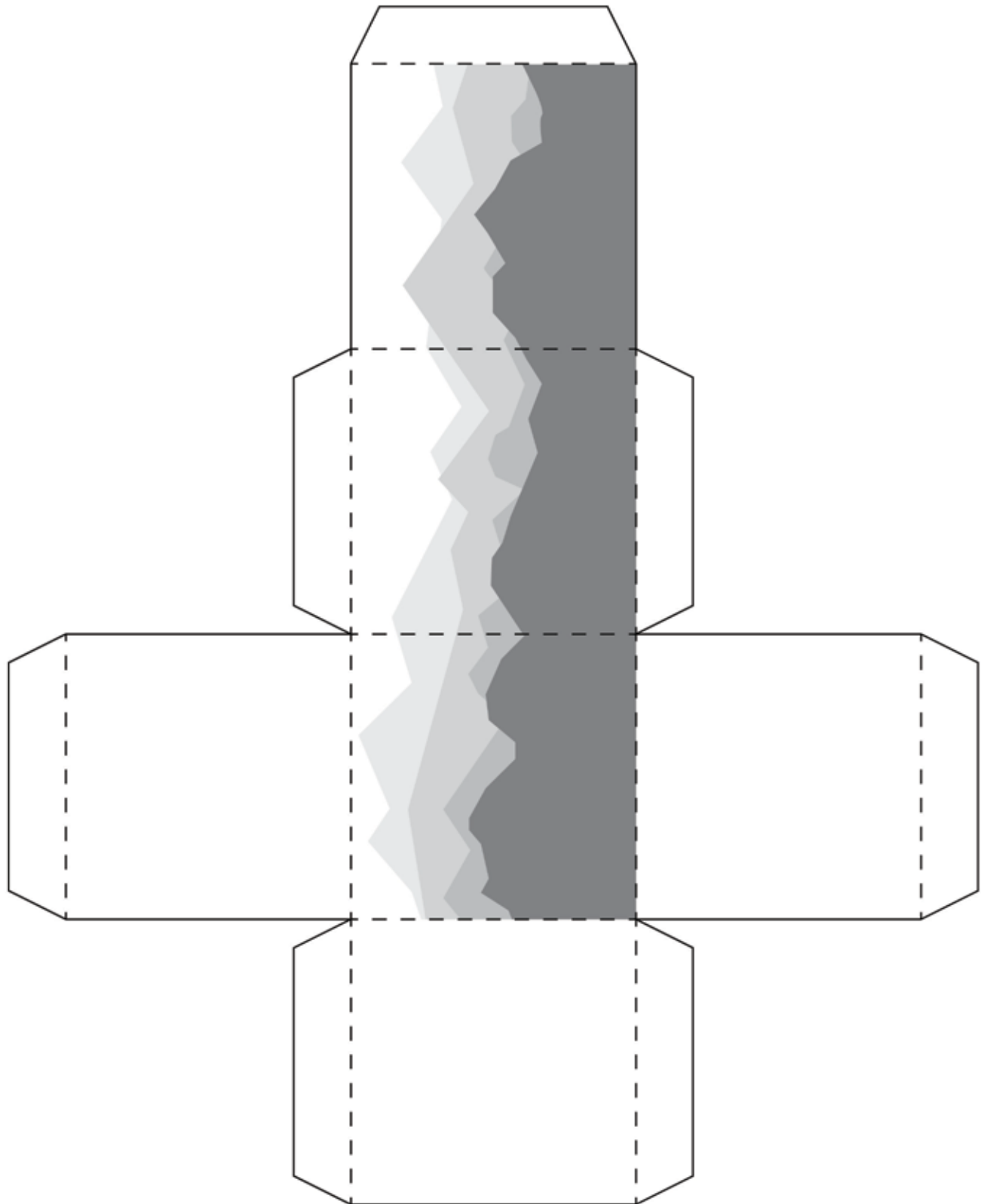







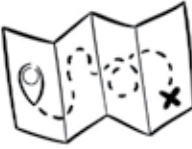



Agregue una aventura a este paisaje montañoso, luego recórtelo en una sola pieza (a lo largo de las líneas continuas). Doble a lo largo de las líneas punteadas, luego pegue con cinta adhesiva para asegurarlo en su lugar.



OUTDOOR ADVENTURE SUDOKU

Fill in the grid with six outdoor items. Each row, column, and square must contain one of each.

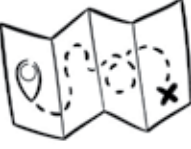









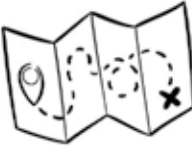





SUDOKU DE AVENTURAS AL AIRE LIBRE

Rellene la cuadrícula con seis elementos al aire libre. Cada fila, columna y cuadrado debe contener uno de cada uno.



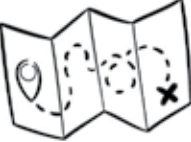







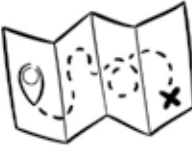













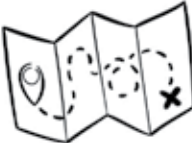







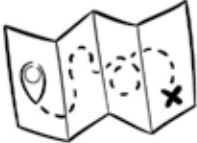



OUTDOOR ADVENTURE SUDOKU - ANSWERS

Fill in the grid with six outdoor items. Each row, column, and square must contain one of each.



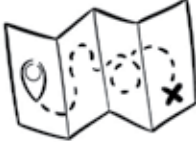

CROSSWORD

- 7 palm
- 8 guitar
- 9 camper
- 4 wave
- 5 helm
- 6 tent
- 1 sunglasses
- 2 surfboard
- 3 lounge

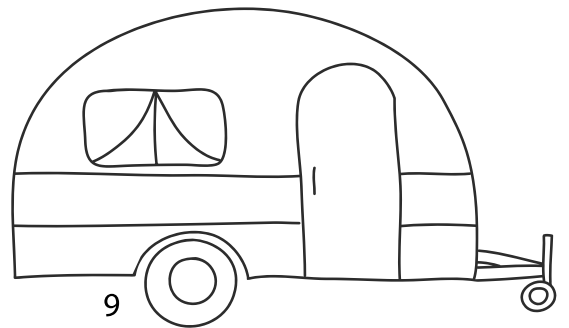
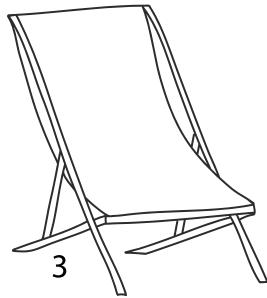
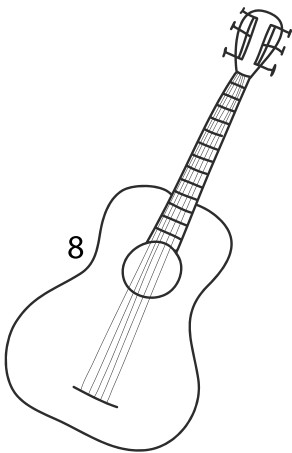
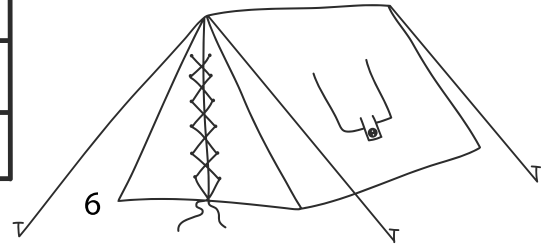
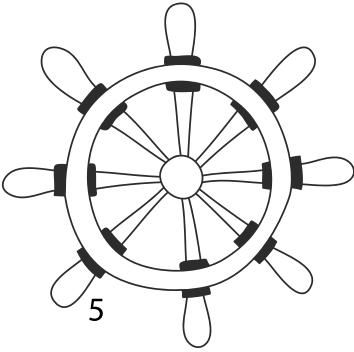
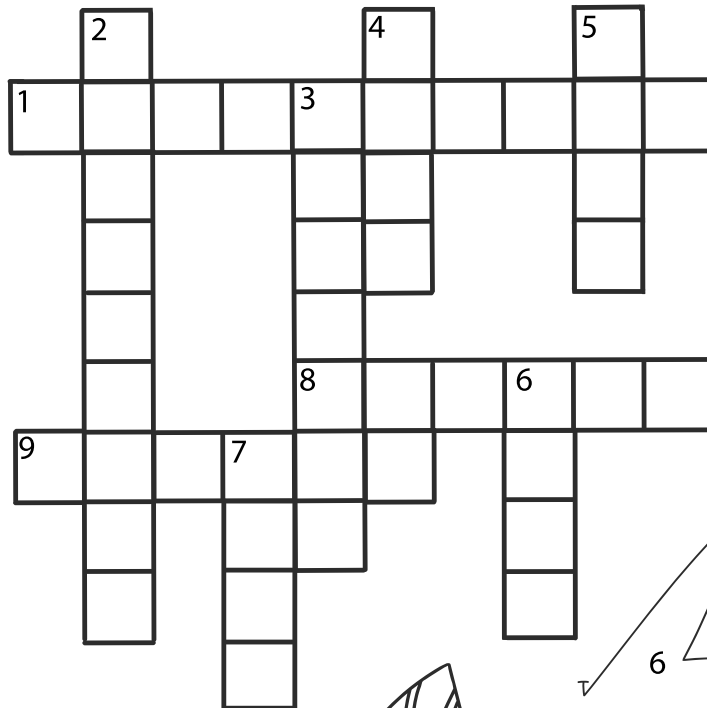
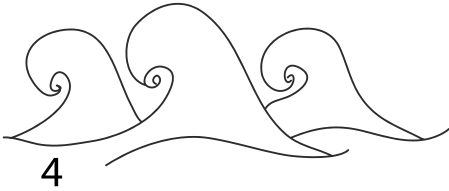

Cut and Glue

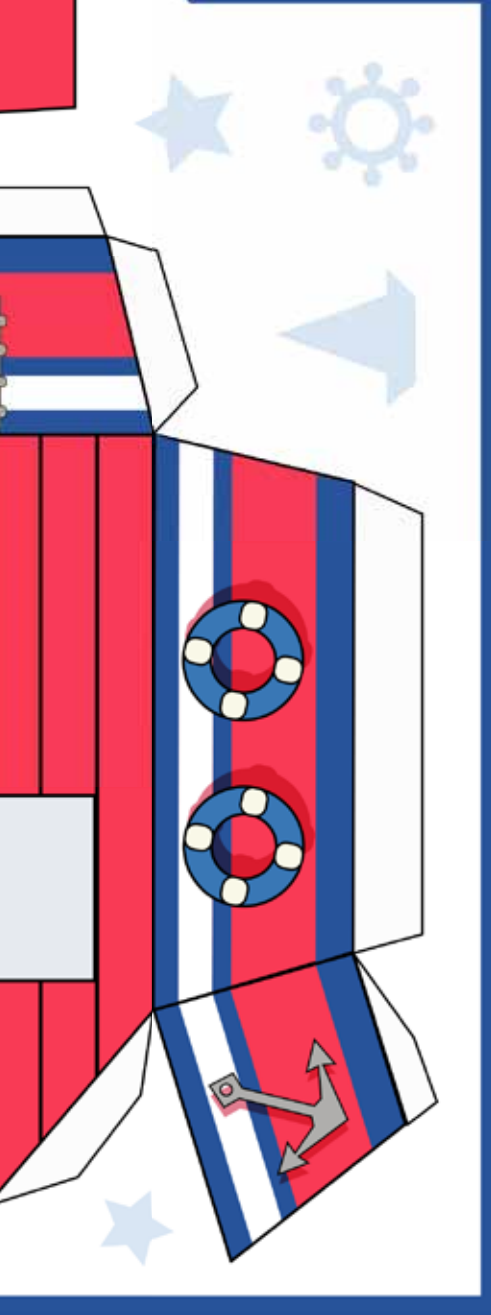
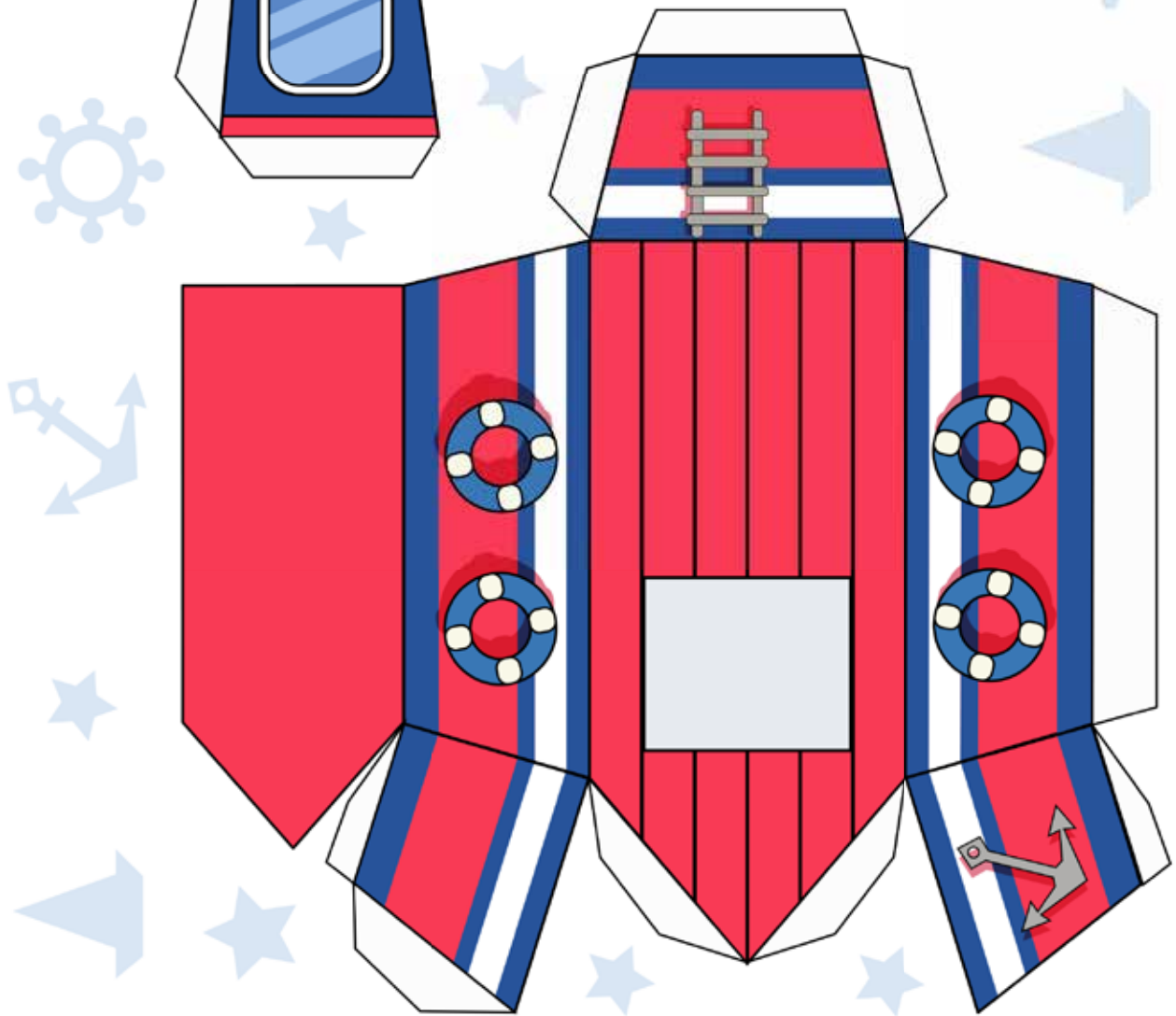
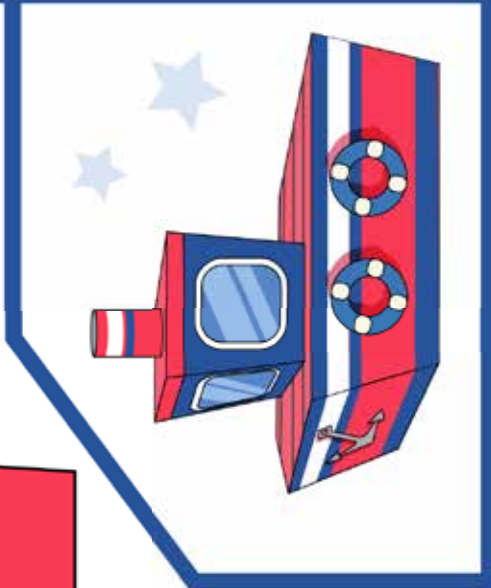
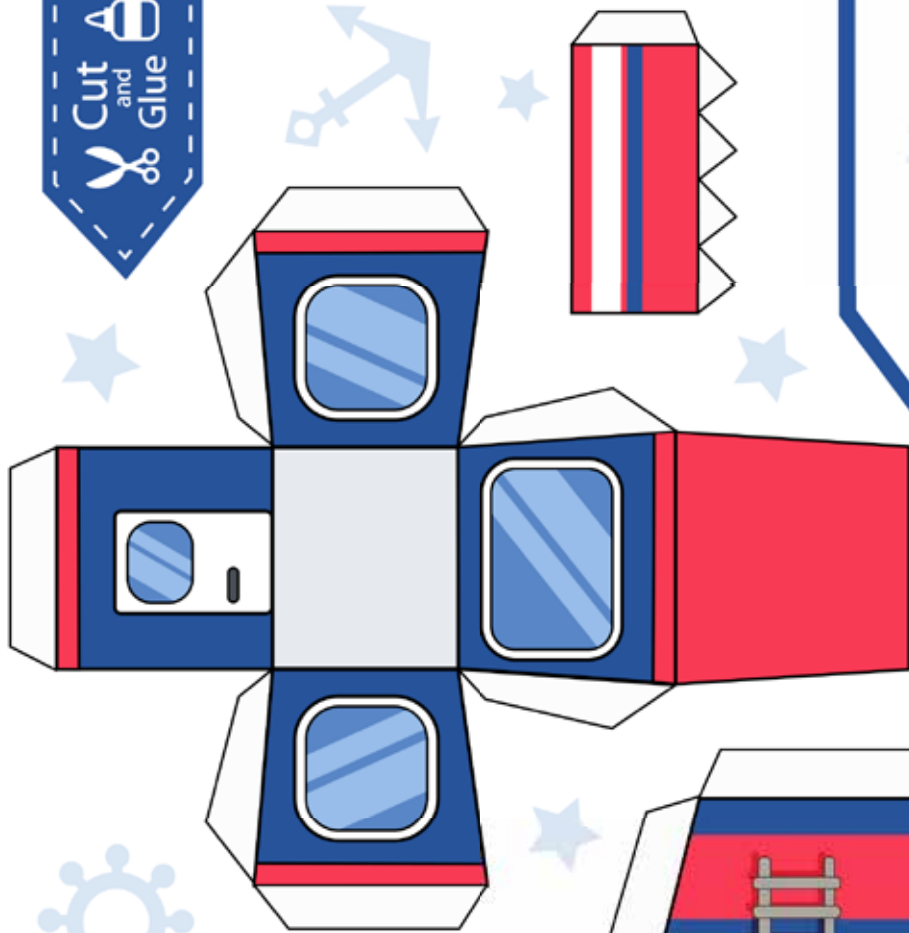

Rompecabezas de búsqueda de palabras



U	C	O	C	H	E	D	X	K	T
E	J	P	S	S	A	N	Ó	W	Q
K	O	E	U	U	E	C	Z	D	L
C	S	S	G	B	N	M	C	B	D
O	H	A	J	M	T	G	R	M	É
H	Ü	I	V	A	R	T	O	Z	Ñ
E	Ü	P	Ó	R	E	D	K	T	Z
T	U	F	G	I	N	D	E	F	G
E	N	D	B	N	A	V	I	Ó	N
R	R	R	F	O	R	Y	M	P	H

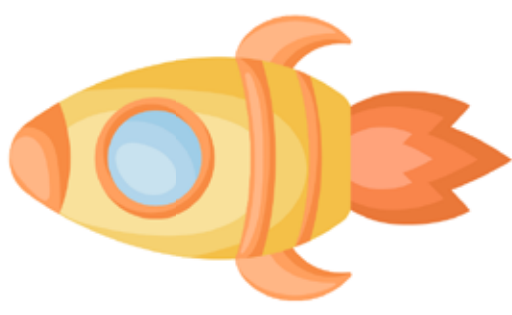

U	C	O	C	H	E	D	X	K	T
E	J	P	S	S	A	N	Ó	W	Q
K	O	E	U	E	C	Z	D	L	
G	S	S	G	B	N	M	C	B	D
H	O	I	V	A	R	T	O	Z	Ñ
E	U	F	G	I	N	D	E	F	G
T	U	F	G	I	N	D	E	F	G
E	N	D	B	N	A	V	I	Ó	N
R	R	R	F	O	R	Y	M	P	H

Crucigrama para niños

A crossword puzzle grid with the following pre-filled letters:

- Vertical word 1 (left): S
- Horizontal word 1 (top): E
- Horizontal word 2 (middle): A
- Vertical word 2 (right): C

Illustrations include:

- A blue submarine with a periscope.
- A yellow car with a blue grille.
- A blue and yellow train with a smokestack.
- A green rocket with orange flames.
- A purple and yellow airplane.

A legend in the bottom right corner shows the words and their corresponding letters in the grid:

- SUBMARINO
- COCHETE
- AVIÓN
- TREN
- ROCKET
- AVIÓN

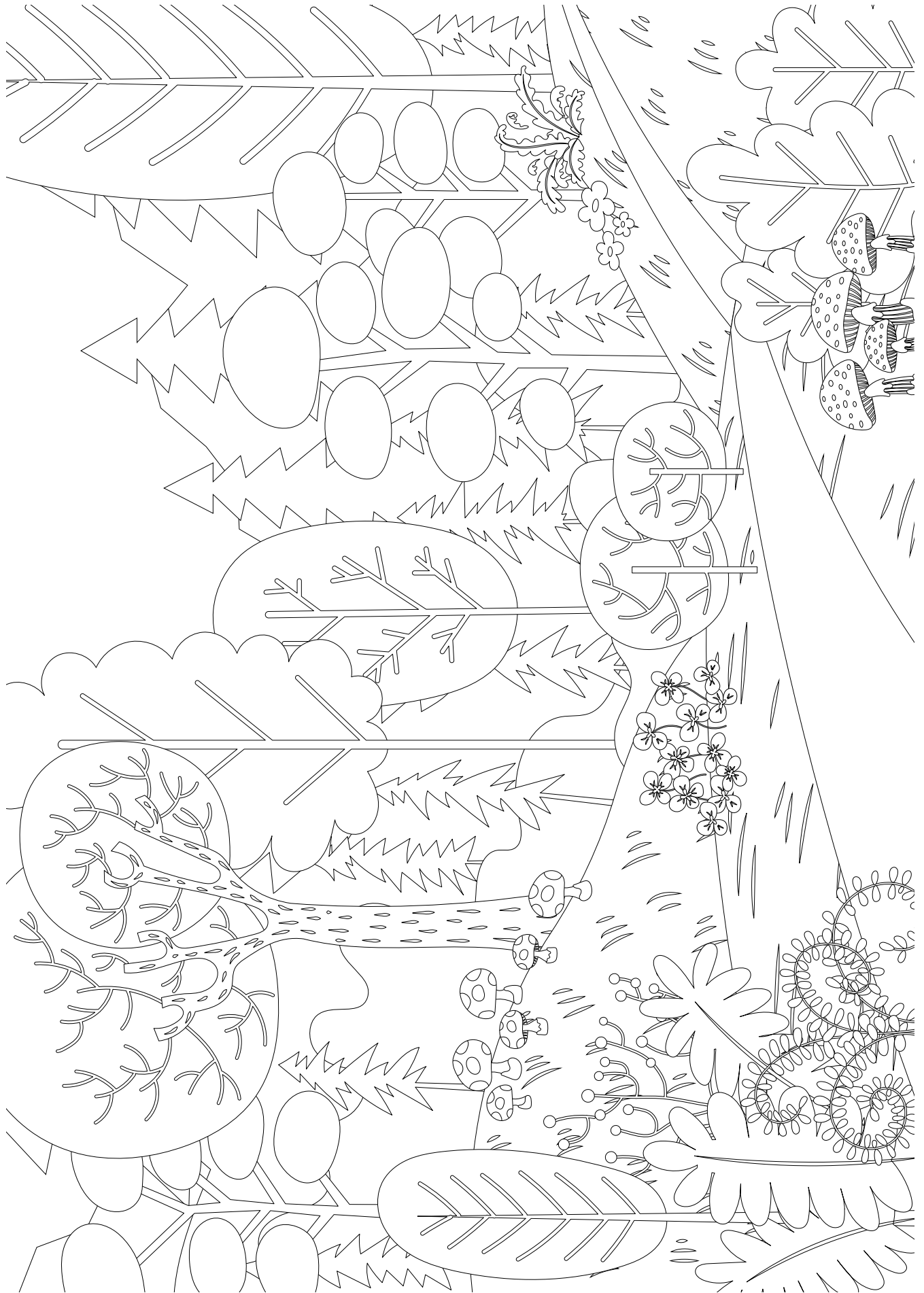

CAMPING JUMBLE

Help! The camping stuff got all mixed up.
How many of each item are in this jumble?

Backpacks _____ Swiss Army Knife _____ Lanterns _____

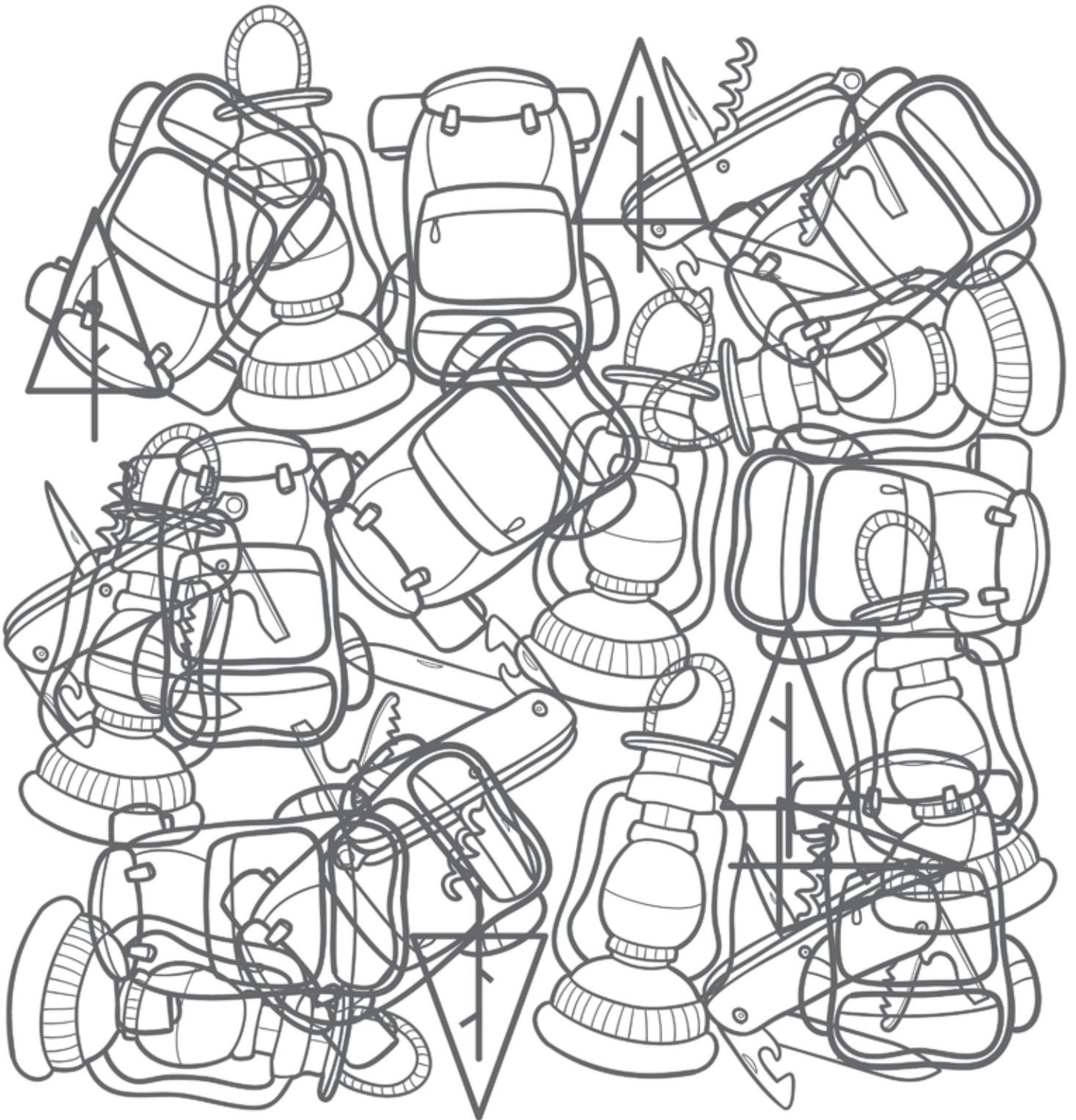

REVOLTIJO DE CAMPAMENTO

¡Ayuda! Las cosas del campamento se mezclaron.
¿Cuántos de cada artículo hay en este revoltijo?

Mochilas _____ Navaja suiza _____ Linternas _____

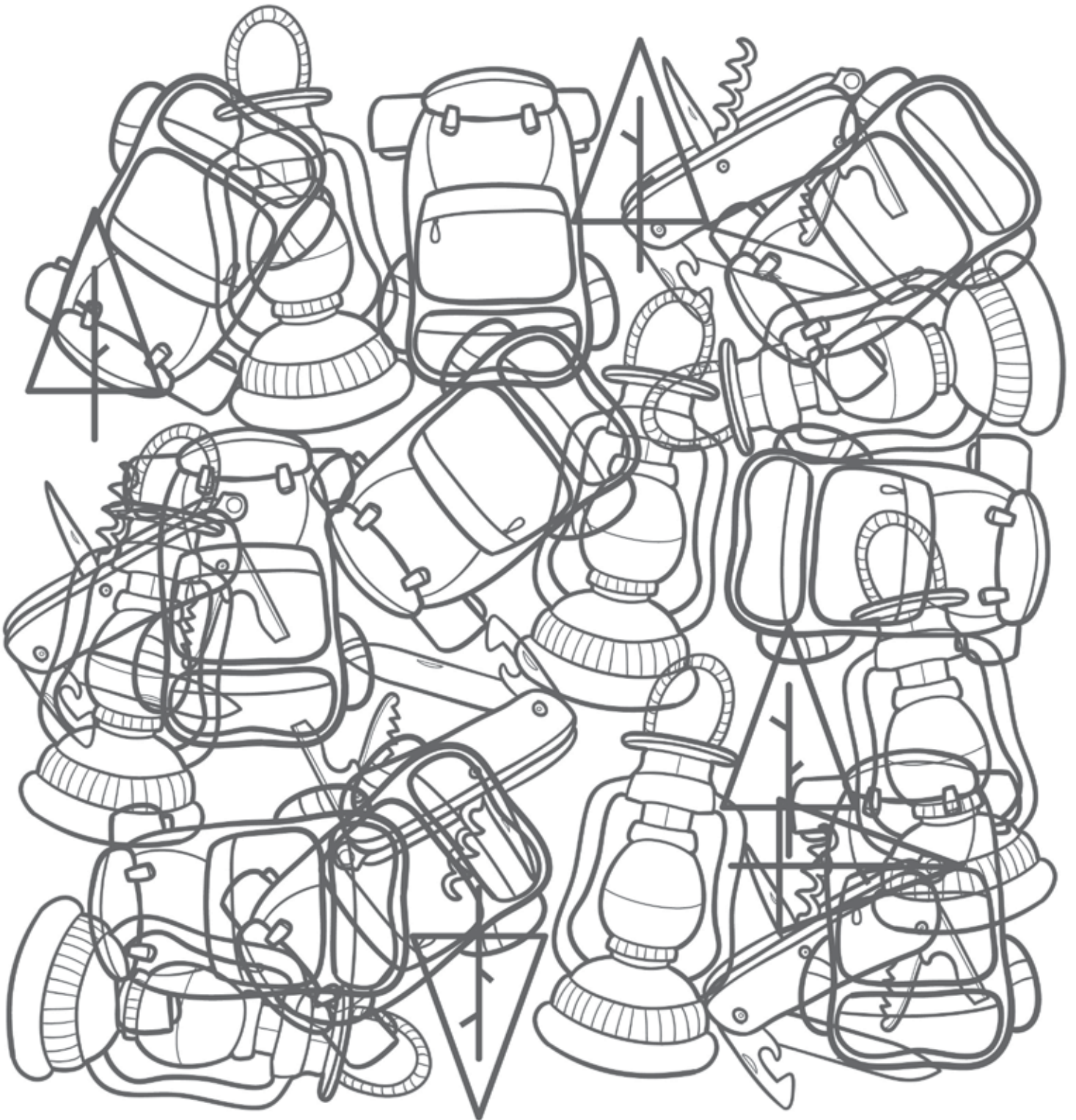

CAMPING JUMBLE- ANSWERS

Help! The camping stuff got all mixed up.
How many of each item are in this jumble?

Backpacks 7 Swiss Army Knife 4 Lanterns 9

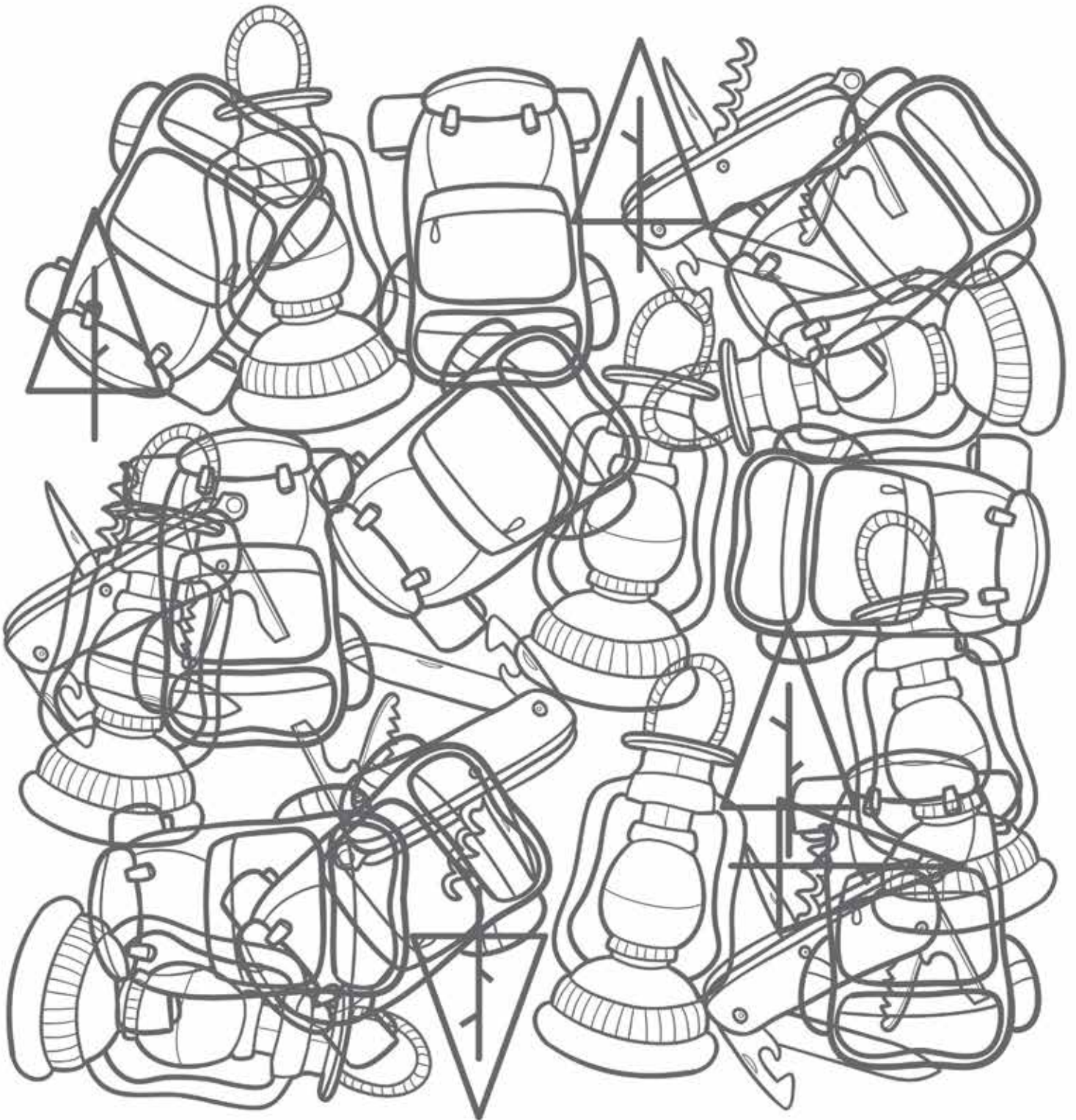

✓ CAMPING CHECKLIST



- Tent
- Sleeping bag
- Chairs
- Books
- Bug repellent
- Sunscreen
- Water
- Food
- Matches

- Flashlight
- First aid kit
- _____
- _____
- _____

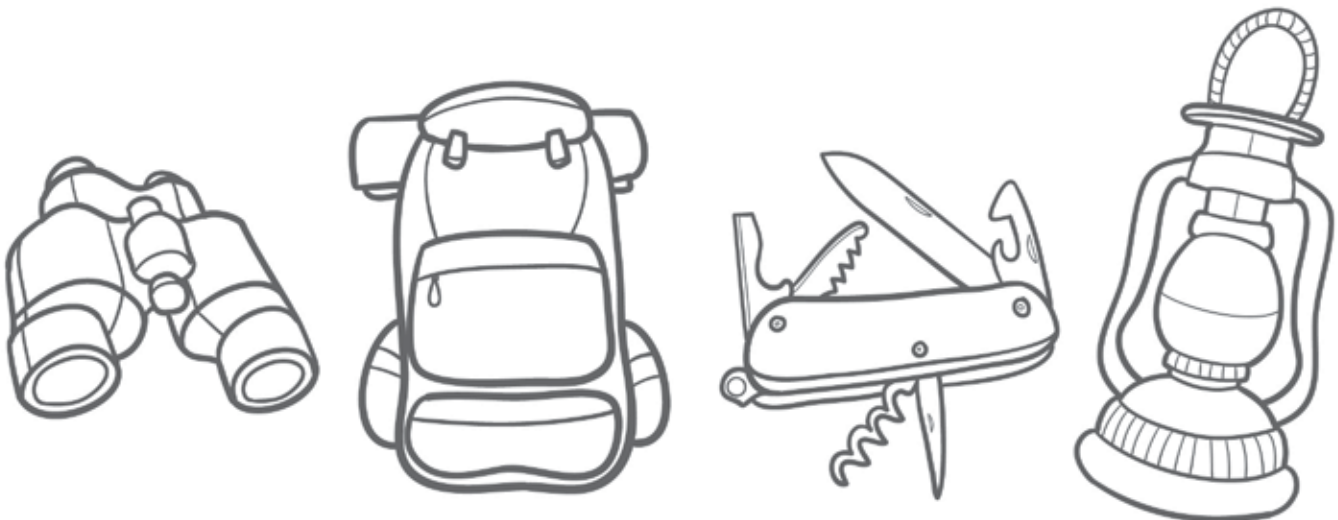



LISTA DE VERIFICACIÓN PARA ACAMPAR



- Carpa
- Bolsa de dormir
- Sillas
- Libros
- Repelente de insectos
- Protector solar
- Agua
- Alimento
- Partidos
- Linterna
- Kit de primeros auxilios
- _____
- _____
- _____

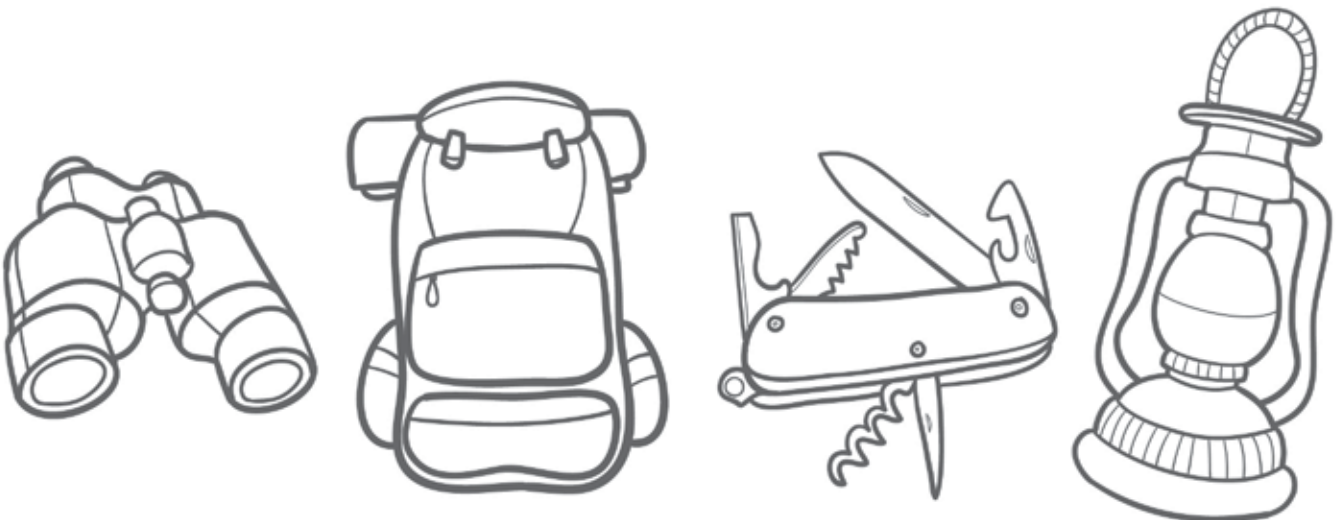

Cut
and
Glue

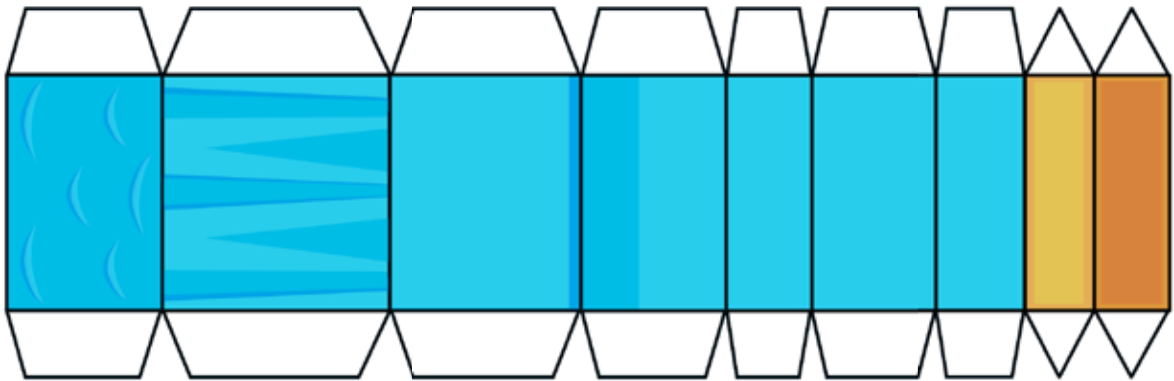
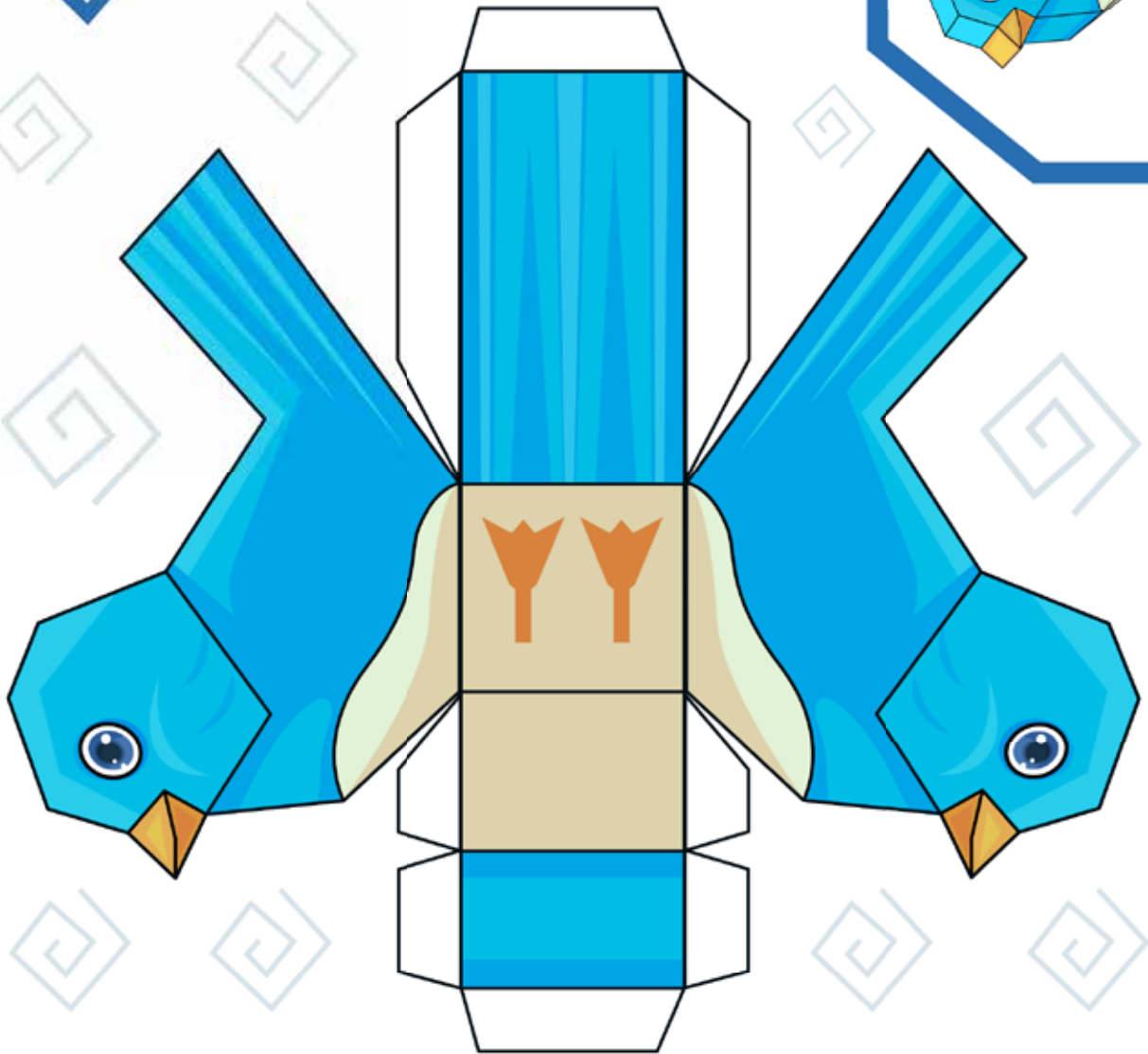
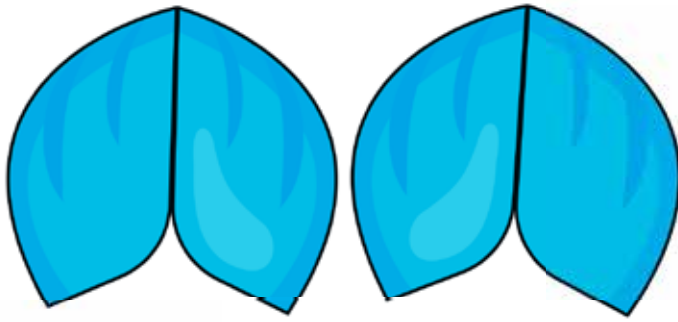

Cut & Glue

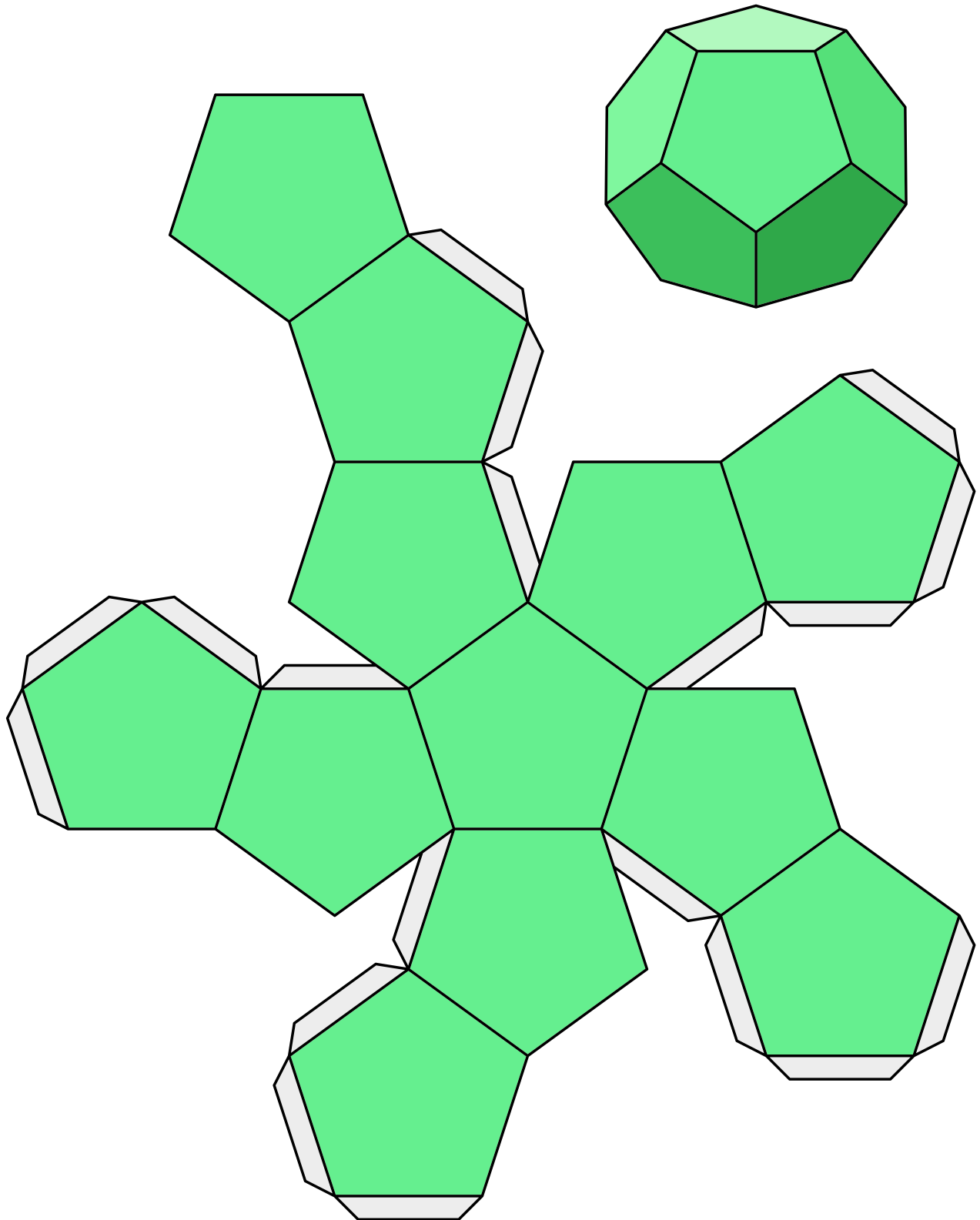

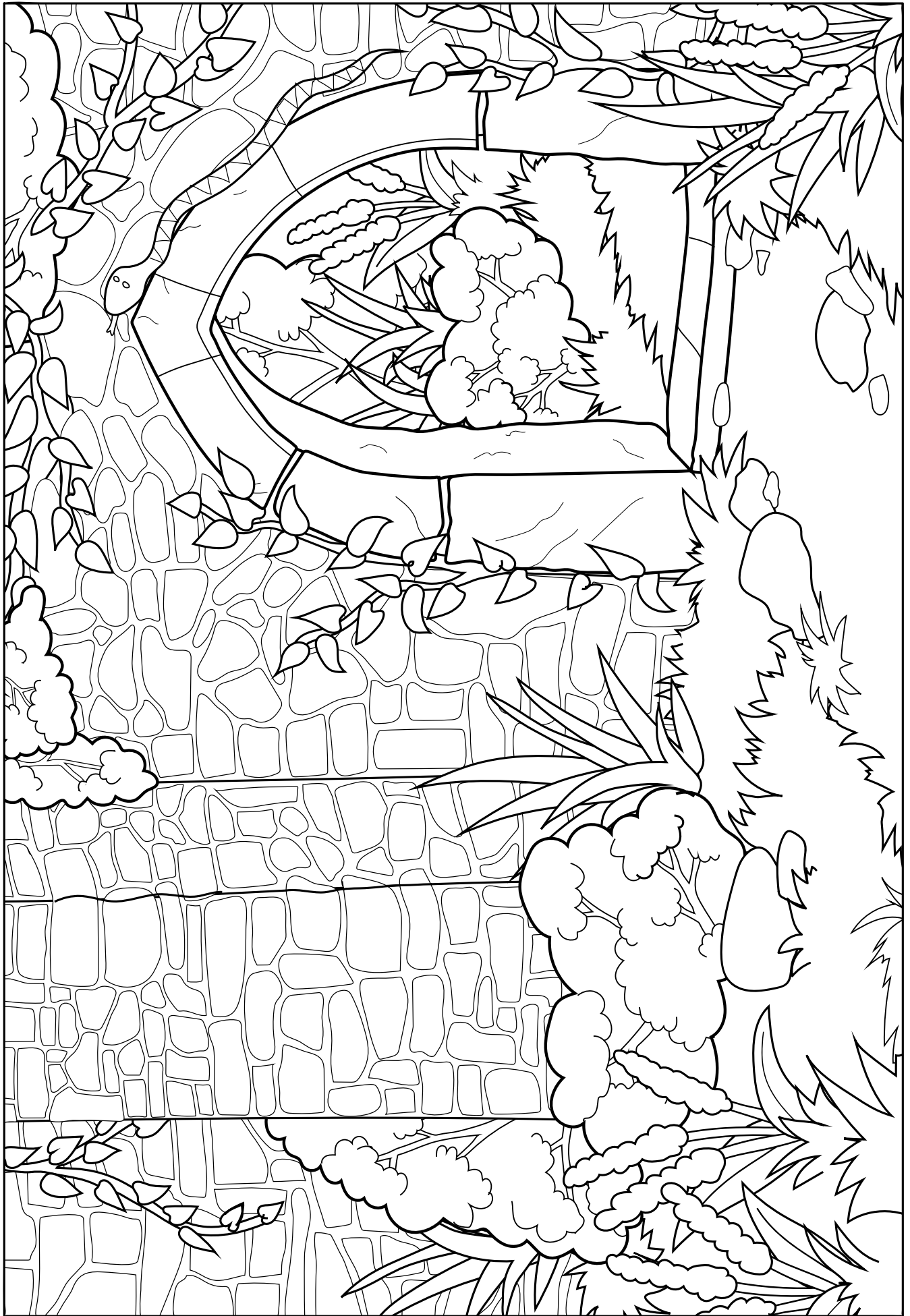

Puzzle game for kids



Answer



Fill in the free cells with numbers from 1 to 8, so that in each row, each column and a small square, the number occurs only 1 time.

1		3		6	8		
	4			8			6
2					7		
	3		3			8	5

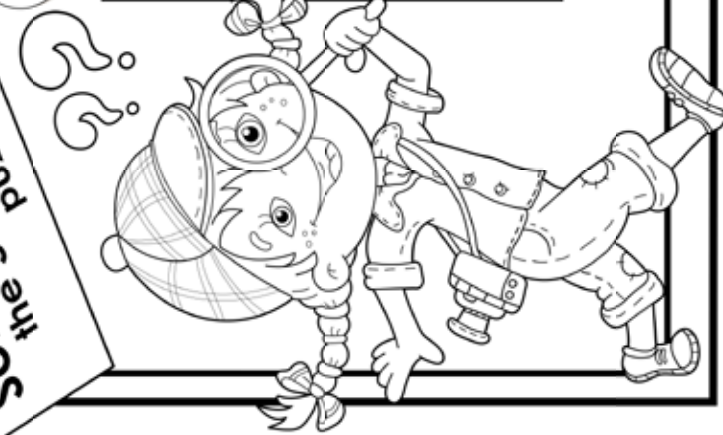

Solve the Sudoku puzzle



1	2	3	4
3	4	2	1
2	1	4	3
4	3	1	2

6	5	8	7
8	7	5	6
5	6	7	8
7	8	6	5

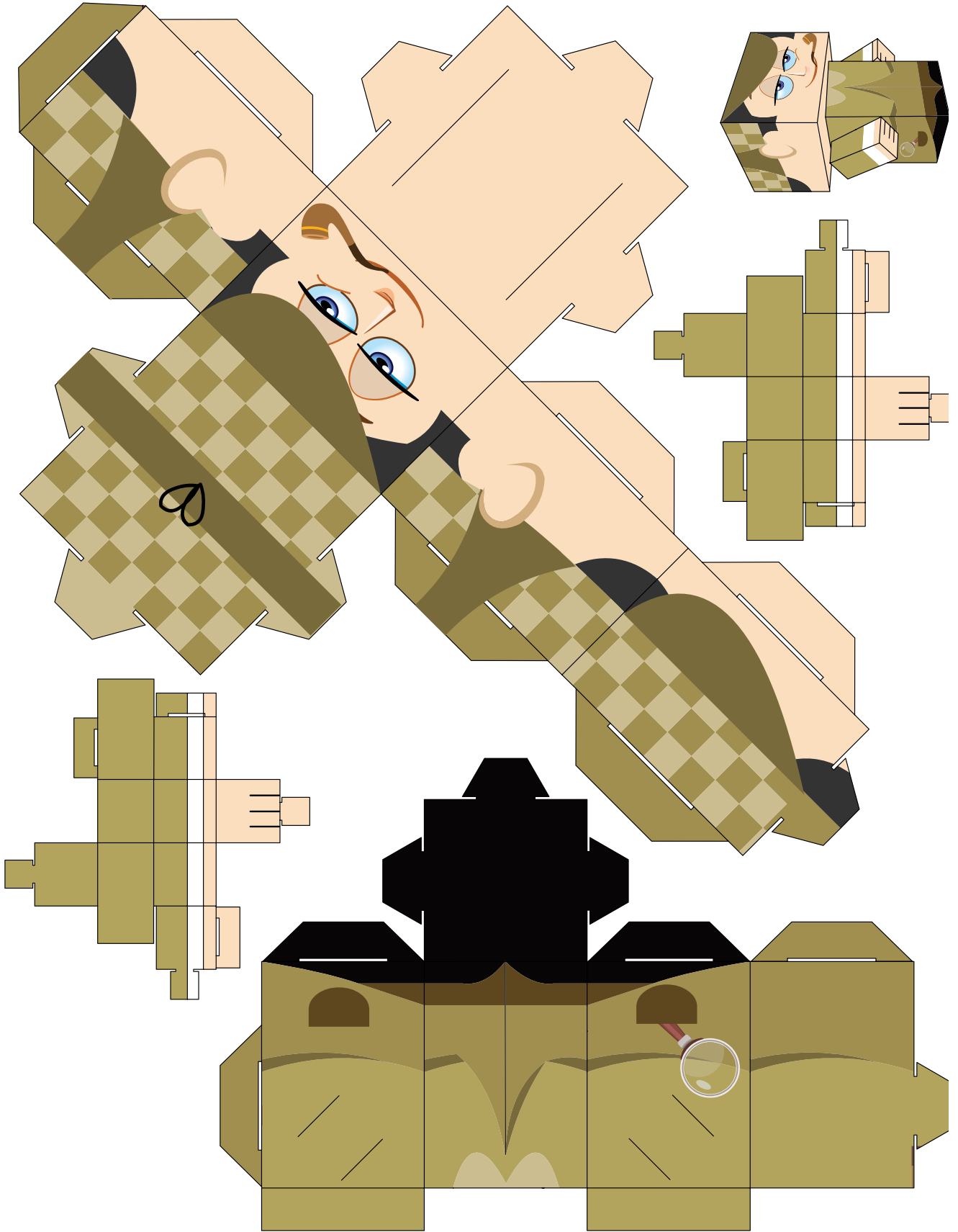

Complete the square from the details

Answer

Answer

Answer

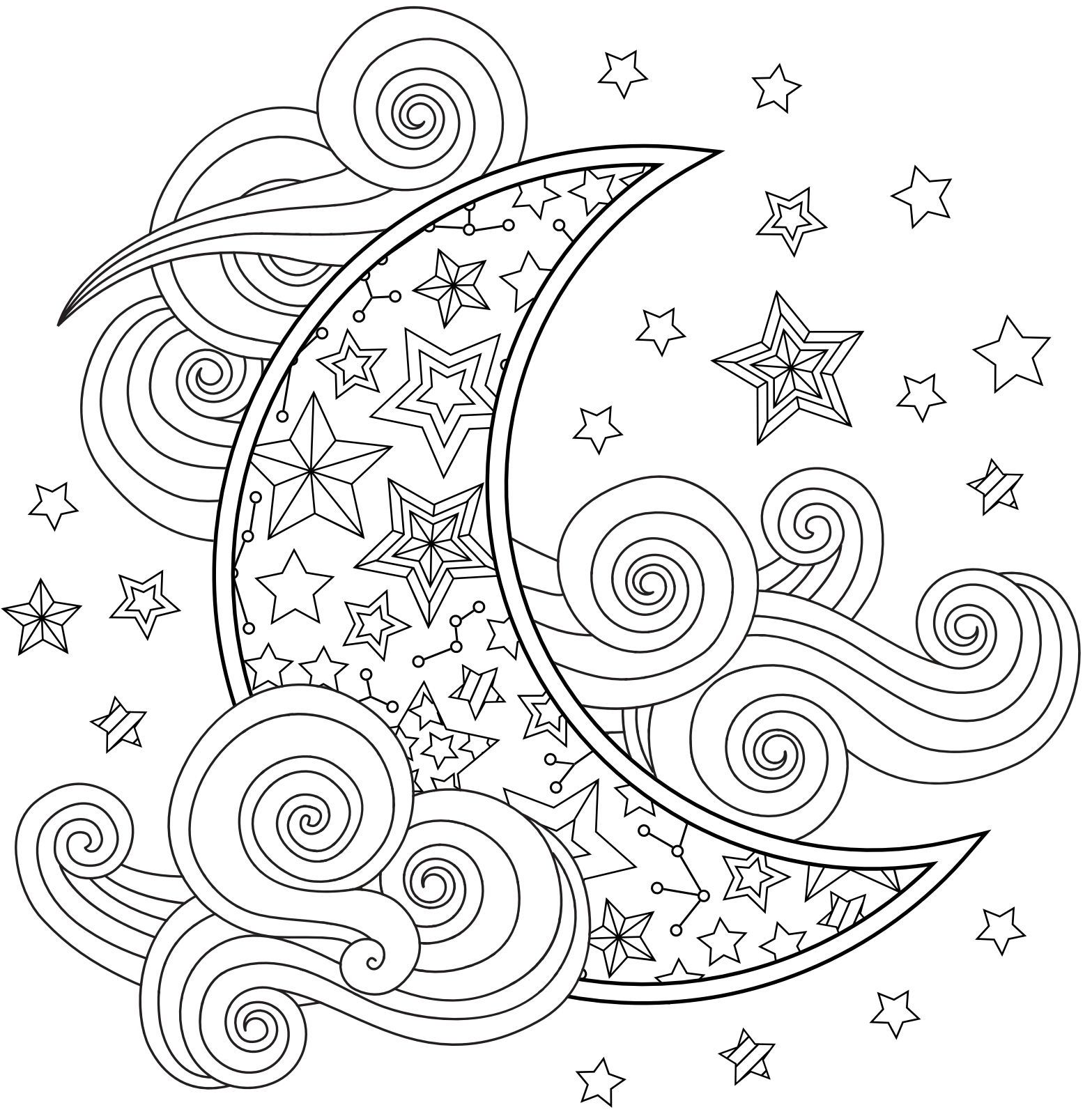

SLEEPOVER CHECKLIST

Sleeping bag

Pillow

Toothbrush

Toothpaste

Pajamas

Change of clothes

Snacks

Notebook

Games

Craft supplies



LISTA DE VERIFICACIÓN DE LA FIESTA DE PIJAMA

Bolsa de dormir

Almohada

Cepillo de dientes

Pasta dental

Pijama

Cambio de ropa

Aperitivos

Computadora portátil

Juegos

Suministros para manualidades



Teen Registration

2024 Summer Library Program

Adventure Begins at Your Library!

Name: _____ Age: _____

Address: _____

Phone or email: _____

School: _____ Grade in September: _____

My favorite book genres (check all that apply):

- | | |
|-------------------------------------|--|
| <input type="checkbox"/> mystery | <input type="checkbox"/> romance |
| <input type="checkbox"/> fantasy | <input type="checkbox"/> science fiction |
| <input type="checkbox"/> classics | <input type="checkbox"/> suspense |
| <input type="checkbox"/> nonfiction | <input type="checkbox"/> graphic novels |
| <input type="checkbox"/> dystopian | <input type="checkbox"/> books in a series |
| <input type="checkbox"/> horror | <input type="checkbox"/> biography |
| <input type="checkbox"/> detective | <input type="checkbox"/> other _____ |

Completed program: Yes No



Teen Reading Contract

2024 Summer Library Program

Adventure Begins at Your Library!

I, _____, do hereby promise to read _____ books or minutes (circle one) between _____ and _____ of the year 2024. I am of junior high or high school age. Furthermore, I state the the aforementioned pages or minutes will relate to titles that are appropriate for my age and sensibilities.

Signed this _____ day of _____, 2024.

Signature of reader

Signature of librarian

Inscripción de lector adolescente

para el programa de verano 2024

¡La aventura comienza en tu biblioteca!

Nombre: _____ Edad: _____

Dirección: _____

Teléfono o email: _____

Escuela: _____ Año en septiembre: _____

Mis géneros de libros favoritos:

(marque todo lo que corresponda)

- | | |
|----------------|------------------------|
| ___ misterio | ___ romance |
| ___ fantasía | ___ ciencia ficción |
| ___ clásico | ___ suspenso |
| ___ no-ficción | ___ novela gráfica |
| ___ distopia | ___ los libros en saga |
| ___ horror | ___ biografía |
| ___ detective | ___ other _____ |

Completó el programa: Sí No



Contrato de lector adolescente

para el programa de biblioteca de verano 2024

¡La aventura comienza en tu biblioteca!

Yo, _____, por la presente prometo leer _____ minutos o libres (encierre uno en un círculo) entre _____ y _____ de 2024. Además, declaro que las páginas mencionados provendrán de títulos que son apropiados para mi edad y mis capacidades.

Firmado este día _____ de _____, 2024.

Firma del lector

Firma del bibliotecario

BOOKS OR AUDIOBOOKS



Adventure Begins at Your Library!



READING LOG

NAME: _____

This book is recommended by

Adventure Begins at Your Library!



This book is recommended by

Adventure Begins at Your Library!



This book is recommended by

Adventure Begins at Your Library!



Este libro está recomendado por

¡La aventura comienza en tu biblioteca!



Este libro está recomendado por

¡La aventura comienza en tu biblioteca!



Este libro está recomendado por

¡La aventura comienza en tu biblioteca!



Book Genre Bingo

Adventure Begins at Your Library!



Name: _____

Read any five in a row (across, down, or diagonal).

biography	translated from a foreign language	novel in verse	thriller	historical fiction
classic	true crime	steampunk	a book in a series	magic realism
science fiction	horror	YOUR CHOICE	dystopian	sports fiction
graphic novel	fantasy	autobiography	suspense	nonfiction
mystery	romance	detective	adventure	made into a movie

Bingo de libros

¡La aventura comienza en tu biblioteca!



Nombre: _____

Lea cualquiera de los cinco en fila (a través, abajo, o diagonalmente).

biografía	traducido de un idioma extranjero	novela poética	thriller	ficción histórica
clásico	crimen verdadero	novela estilo Victoriana	un libro en saga	realismo mágico
ciencia ficción	horror	TU ELECCIÓN	distopia	ficción deportiva
novela gráfica	fantasía	autobiografía	suspenso	no-ficción
misterio	romance	detective	aventura	convertido en película

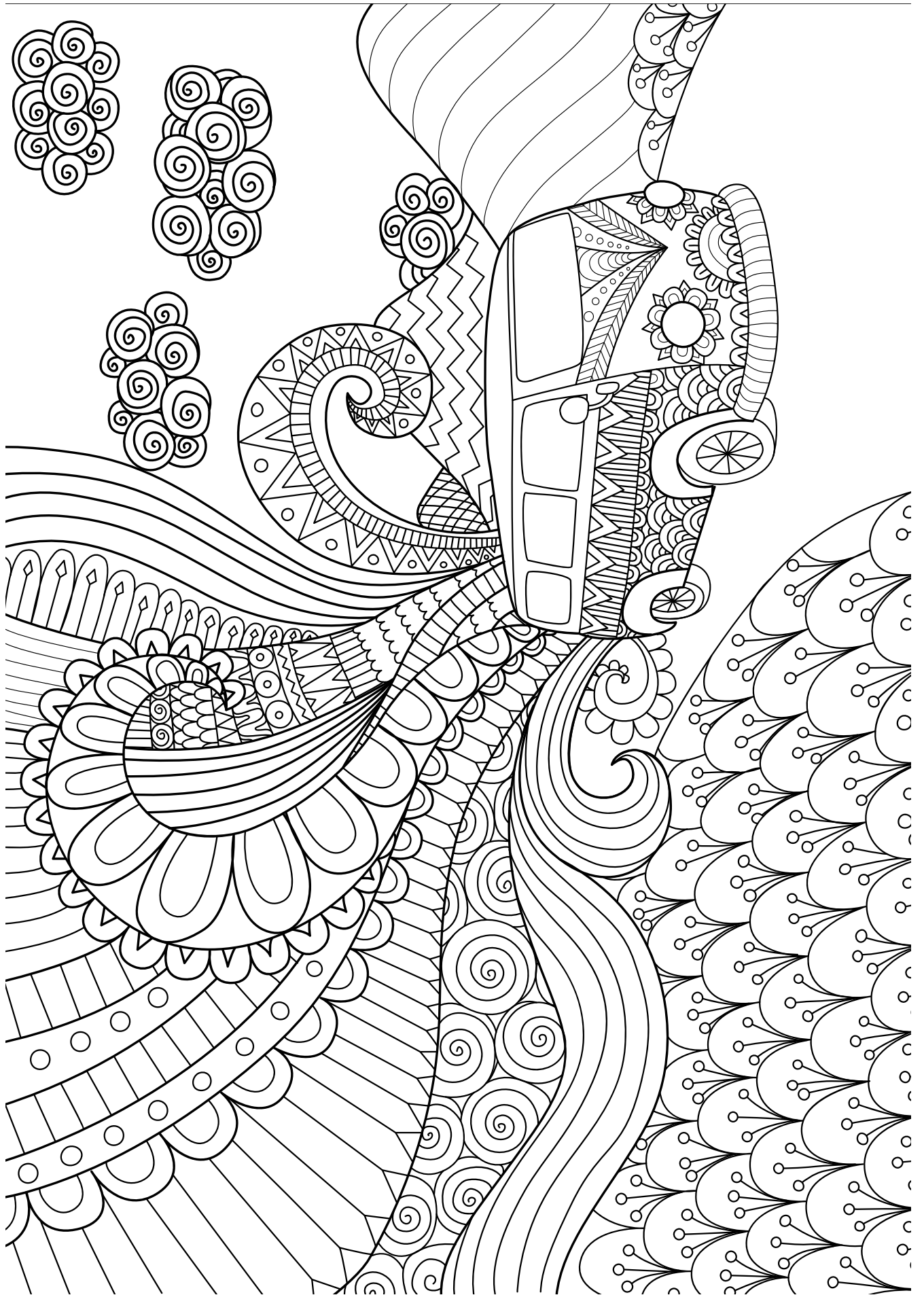

Cut and Glue

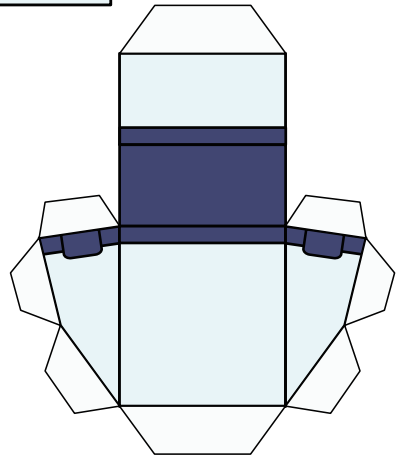
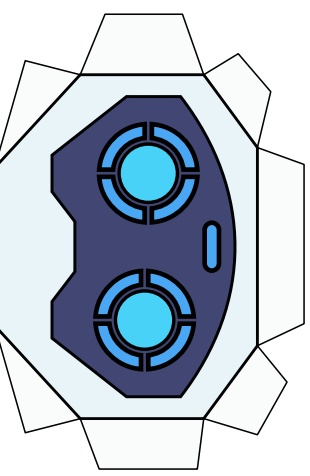
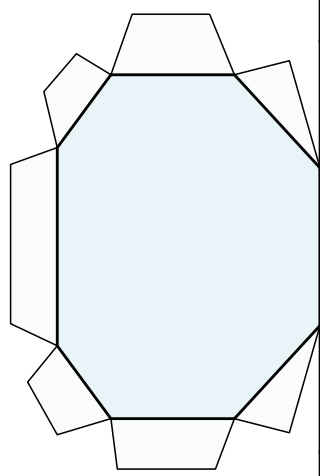
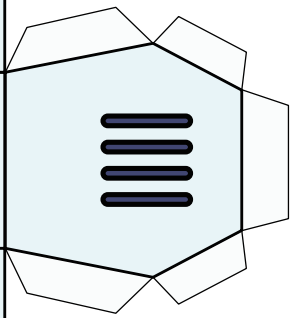
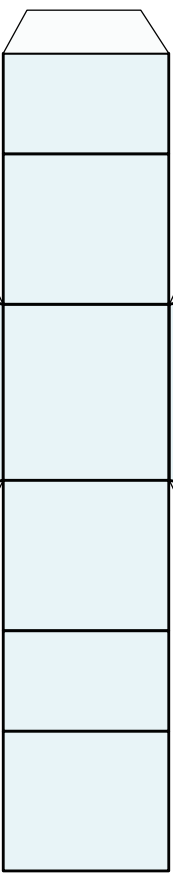
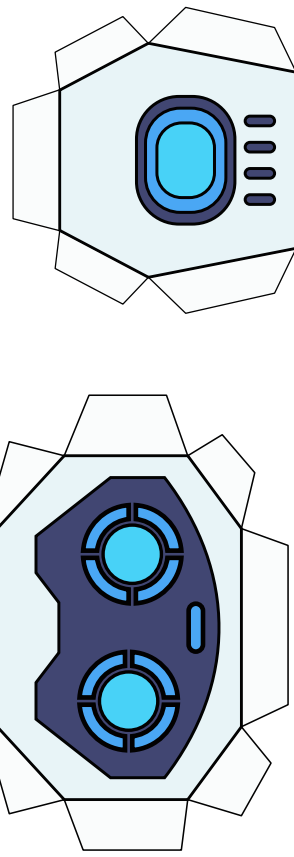
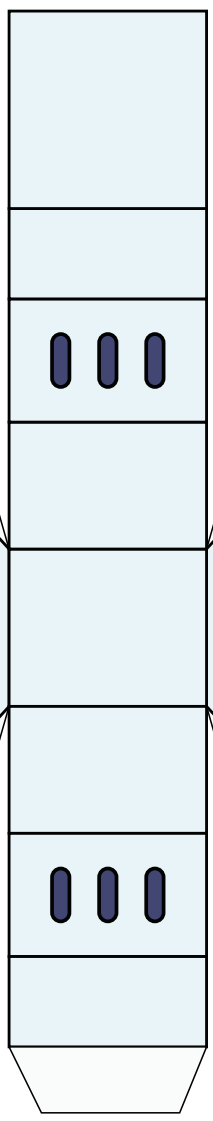
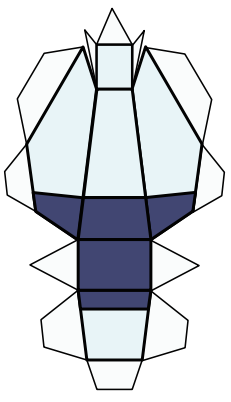
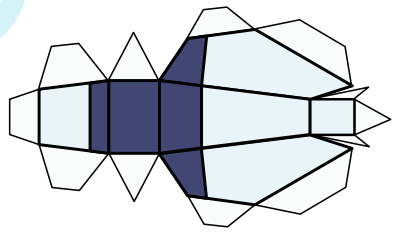
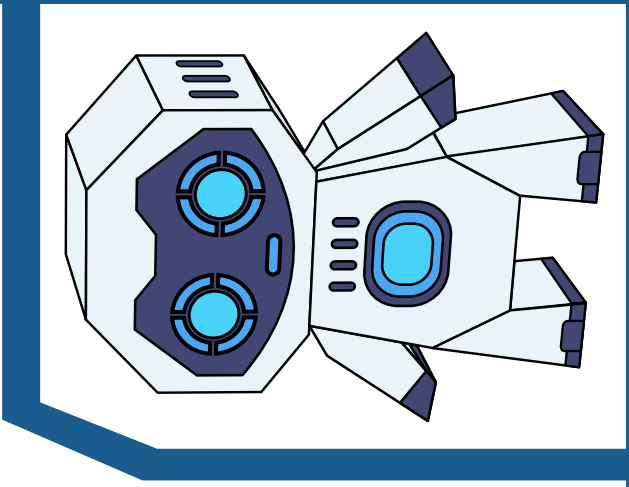
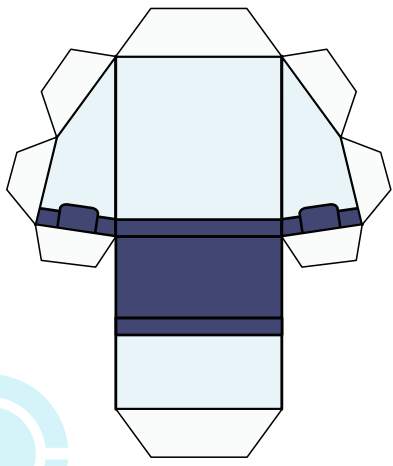

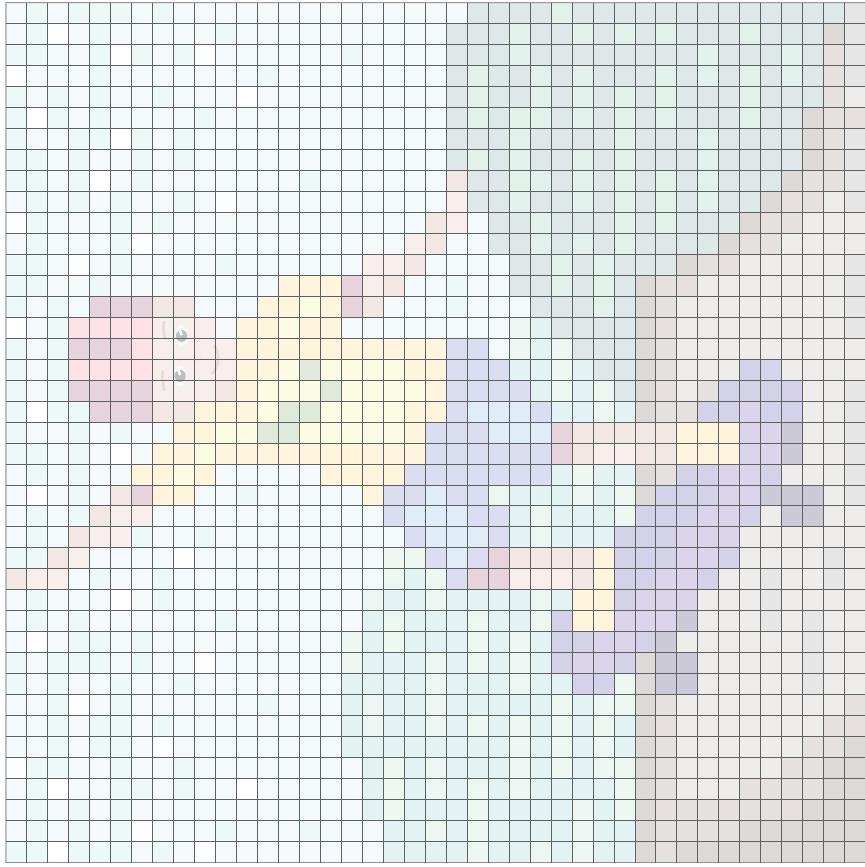

- | | | | | | | | | | | | | | | | | | | | |
|---|---|---|---|---|---|---|---|---|---|----|----|----|----|----|----|----|----|----|----|
| 0 | 1 | 2 | 3 | 4 | 5 | 6 | 7 | 8 | 9 | 10 | 11 | 12 | 13 | 14 | 15 | 16 | 17 | 18 | 19 |
|---|---|---|---|---|---|---|---|---|---|----|----|----|----|----|----|----|----|----|----|

